

HIGHLIGHTS OF PRESCRIBING INFORMATION

These highlights do not include all the information needed to use XYNTHA safely and effectively. See full prescribing information for XYNTHA.

XYNTHA® SOLOFUSE™ (antihemophilic factor [recombinant]) lyophilized powder for solution in prefilled dual-chamber syringe, for intravenous injection
Initial U.S. Approval: 2008

RECENT MAJOR CHANGES

Indications and Usage (1) 10/2014

INDICATIONS AND USAGE

- XYNTHA is a recombinant antihemophilic factor indicated in adults and children with hemophilia A for control and prevention of bleeding episodes and for perioperative management. (1)
- XYNTHA is not indicated in patients with von Willebrand's disease. (1)

DOSAGE AND ADMINISTRATION

For intravenous use after reconstitution only (2)

- The required dose is determined using the following formula:
Required units = body weight (kg) x desired factor VIII rise (IU/dL or % of normal) x 0.5 (IU/kg per IU/dL), where IU = International Unit.
- Frequency of XYNTHA administration is determined by the type of bleeding episode and the recommendation of the treating physician. (2.1, 2.2)

DOSAGE FORMS AND STRENGTHS

XYNTHA SOLOFUSE is available as lyophilized powder in single-use prefilled dual-chamber syringes containing nominally 250, 500, 1000, 2000, or 3000 IU. (3)

CONTRAINDICATIONS

Do not use in patients who have manifested life-threatening immediate hypersensitivity reactions, including anaphylaxis, to the product or its

components, including hamster proteins. (4)

WARNINGS AND PRECAUTIONS

- Anaphylaxis and severe hypersensitivity reactions are possible. Patients may develop hypersensitivity to hamster protein, which is present in trace amounts in XYNTHA. Should such reactions occur, discontinue treatment with the product, and administer appropriate treatment. (5.1)
- Development of activity-neutralizing antibodies has been detected in patients receiving factor VIII-containing products, including XYNTHA. If expected plasma factor VIII activity levels are not attained, or if bleeding is not controlled with an appropriate dose, perform an assay that measures factor VIII inhibitor concentration. (5.2, 5.3, 6.2)

ADVERSE REACTIONS

- The most common adverse reactions (≥ 10%) with XYNTHA in adult and pediatric PTPs were headache, arthralgia, pyrexia, and cough. (6)
- Across all studies, 3 subjects developed factor VIII inhibitors (2.1%). (6.2)

To report SUSPECTED ADVERSE REACTIONS, contact Wyeth Pharmaceuticals Inc. at 1-800-438-1985 or FDA at 1-800-FDA-1088 or www.fda.gov/medwatch

USE IN SPECIFIC POPULATIONS

- Pregnancy: No human or animal data. Use only if clearly needed. (8.1)
- Pediatrics: Half-lives are shorter, volumes of distribution are larger, and recovery is lower after XYNTHA administration in children. Higher or more frequent dosing may be needed. (8.4)

See 17 for PATIENT COUNSELING INFORMATION and FDA-approved patient labeling

Revised: 10/2014

FULL PRESCRIBING INFORMATION: CONTENTS *

1 INDICATIONS AND USAGE

2 DOSAGE AND ADMINISTRATION

- 2.1 Dosing
- 2.2 Preparation and Reconstitution
- 2.3 Administration
- 2.4 Use of a XYNTHA Vial Kit and a XYNTHA® SOLOFUSE™ Kit
- 2.5 Use of Multiple XYNTHA® SOLOFUSE™

3 DOSAGE FORMS AND STRENGTHS

4 CONTRAINDICATIONS

5 WARNINGS AND PRECAUTIONS

- 5.1 Hypersensitivity Reactions
- 5.2 Neutralizing Antibodies
- 5.3 Monitoring Laboratory Tests

6 ADVERSE REACTIONS

- 6.1 Clinical Trials Experience
- 6.2 Immunogenicity
- 6.3 Postmarketing Experience

8 USE IN SPECIFIC POPULATIONS

- 8.1 Pregnancy
- 8.2 Labor and Delivery
- 8.3 Nursing Mothers
- 8.4 Pediatric Use
- 8.5 Geriatric Use

11 DESCRIPTION

12 CLINICAL PHARMACOLOGY

- 12.1 Mechanism of Action
- 12.2 Pharmacodynamics
- 12.3 Pharmacokinetics

13 NONCLINICAL TOXICOLOGY

- 13.1 Carcinogenesis, Mutagenesis, Impairment of Fertility
- 13.2 Animal Toxicology and/or Pharmacology

14 CLINICAL STUDIES

15 REFERENCES

16 HOW SUPPLIED/STORAGE AND HANDLING

17 PATIENT COUNSELING INFORMATION

* Sections or subsections omitted from the full prescribing information are not listed

FULL PRESCRIBING INFORMATION

1 INDICATIONS AND USAGE

XYNTHA, Antihemophilic Factor (Recombinant), is indicated for use in adults and children with hemophilia A (congenital factor VIII deficiency) for:

- Control and prevention of bleeding episodes
- Perioperative management

XYNTHA does not contain von Willebrand factor, and therefore is not indicated in patients with von Willebrand's disease.

2 DOSAGE AND ADMINISTRATION

For intravenous use after reconstitution only.

2.1 Dose

- Initiate treatment with XYNTHA under the supervision of a physician experienced in the treatment of hemophilia A.
- Dosage and duration of treatment depend on the severity of the factor VIII deficiency, the location and extent of bleeding, and the patient's clinical condition. Titrate the administered doses to the patient's clinical response.
- One International Unit (IU) of factor VIII activity corresponds approximately to the quantity of factor VIII in one milliliter of normal human plasma. The calculation of the required dosage of factor VIII is based upon the empirical finding that, on average, 1 IU of factor VIII per kg body weight raises the plasma factor VIII activity by approximately 2 IU/dL.²

The expected in vivo peak increase in factor VIII level expressed as IU/dL (or % normal) can be estimated using the following formulas:

Dosage (International Units) = body weight (kg) x desired factor VIII rise (IU/dL or % of normal) x 0.5 (IU/kg per IU/dL)

or

IU/dL (or % normal) = Total Dose (IU)/body weight (kg) x 2 [IU/dL]/[IU/kg]

Control and Prevention of Bleeding Episodes

A guide for dosing XYNTHA for the control and prevention of bleeding episodes is provided in Table 1. Maintain the plasma factor VIII activity at or above the levels (in % of normal or in IU/dL) outlined in Table 1 for the indicated period.

Table 1: Dosing for Control and Prevention of Bleeding Episodes

Type of Bleeding Episode	Factor VIII Level Required (IU/dL or % of normal)	Frequency of Doses (hours)	Duration of Therapy
Minor Early hemarthrosis, minor muscle or oral bleeds.	20-40	12-24	At least 1 day, depending upon the severity of the bleeding episode.
Moderate Bleeding into muscles. Mild head trauma. Bleeding into the oral cavity.	30-60	12-24	3-4 days or until adequate local hemostasis is achieved.
Major Gastrointestinal bleeding. Intracranial, intra-abdominal or intrathoracic bleeding. Fractures.	60-100	8-24	Until bleeding is resolved.

Perioperative Management

A guide for dosing XYNTHA during surgery (perioperative management) is provided in Table 2. Maintain the plasma factor VIII activity level at or above the level (in % of normal or in IU/dL) outlined in Table 2 for the indicated period. Monitor the replacement therapy by means of plasma factor VIII activity.

Table 2: Dosing for Perioperative Management

Type of Surgery	Factor VIII Level Required (IU/dL or % of normal)	Frequency of Doses (hours)	Duration of Therapy (days)
Minor Minor operations, including tooth extraction.	30-60	12-24	3-4 days or until adequate local hemostasis is achieved. For tooth extraction, a single infusion plus oral antifibrinolytic therapy within 1 hour may be sufficient.

Type of Surgery	Factor VIII Level Required (IU/dL or % of normal)	Frequency of Doses (hours)	Duration of Therapy (days)
Major Major operations.	60-100	8-24	Until threat is resolved, or in the case of surgery, until adequate local hemostasis and wound healing are achieved.

2.2 Preparation and Reconstitution

Preparation

1. Always wash hands before performing the following procedures.
2. Use aseptic technique during the reconstitution procedures.
3. Use all components for the reconstitution and administration of this product as soon as possible after opening their sterile containers to minimize unnecessary exposure to the atmosphere.

Note:

- If the patient uses one vial of XYNTHA with one XYNTHA[®] SOLOFUSE[™] for the infusion, reconstitute the vial and the syringe according to the instructions for that respective product kit. Use a separate 10 milliliter or larger luer lock syringe (not included in this kit) to draw back the reconstituted contents of the vial and the syringe. [see *Dosage and Administration (2.4)*]
- If the patient uses multiple XYNTHA SOLOFUSE syringes for the infusion, reconstitute each syringe according to the instructions below. Use a separate 10 milliliter or larger luer lock syringe (not included in this kit) to draw back the reconstituted contents of each syringe. [see *Dosage and Administration (2.5)*]

Reconstitution

1. Allow the XYNTHA SOLOFUSE Kit to reach room temperature.
2. Remove the contents of the XYNTHA[®] SOLOFUSE[™] Kit and place on a clean surface, making sure you have all the supplies you will need.
3. Grasp the plunger rod as shown in the following diagram. Avoid contact with the shaft of the plunger rod. Screw the plunger rod firmly into the opening in the finger rest of the XYNTHA[®] SOLOFUSE[™] by pushing and turning firmly until resistance is felt (approximately 2 turns).

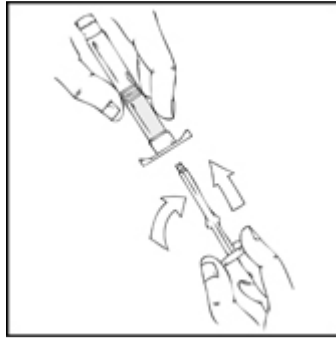

Note: Once the white tamper-evident seal is removed it is important to keep the XYNTHA[®] SOLOFUSE[™] in the upright position throughout the reconstitution process to prevent possible leakage.

4. Holding the XYNTHA[®] SOLOFUSE[™] upright, remove the white tamper-evident seal by bending the seal right to left (or a gentle rocking motion) to break the perforation of the cap and expose the grey rubber tip cap of the XYNTHA[®] SOLOFUSE[™].



5. Remove the protective blue vented sterile cap from its package. While holding the XYNTHA[®] SOLOFUSE[™] upright, remove the grey rubber tip cap and replace it with the protective blue vented cap (prevents pressure build-up). Avoid touching the open end of both the syringe and the protective blue vented cap.

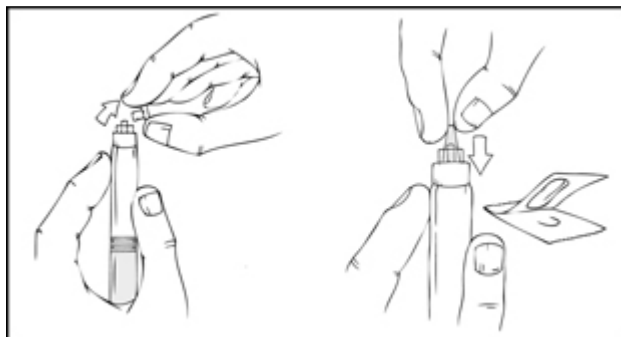

6. **Gently and slowly** advance the plunger rod by pushing until the two stoppers inside the XYNTHA[®] SOLOFUSE[™] meet, and all of the diluent is transferred to the chamber containing the XYNTHA powder.

Note: To prevent the escape of fluid from the tip of the syringe, the plunger rod should not be pushed with excessive force.

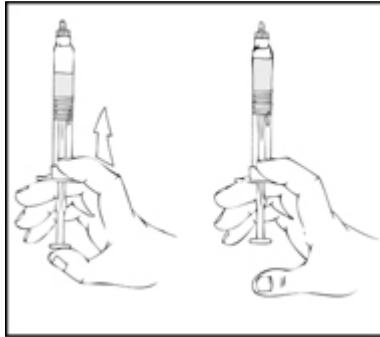

7. With the XYNTHA[®] SOLOFUSE[™] remaining upright, swirl **gently** several times until the powder is dissolved.

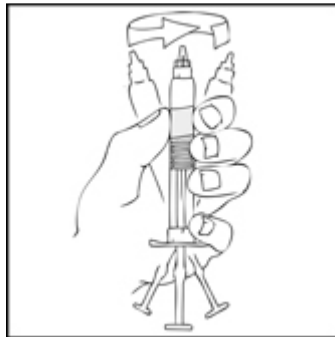

Note: The final solution should be inspected visually for particulate matter before administration. The solution should be clear to slightly opalescent and colorless. If it is not, discard the solution and use a new kit.

8. Holding the XYNTHA[®] SOLOFUSE[™] in an upright position, slowly advance the plunger rod until most, but not all, of the air is removed from the drug product chamber.

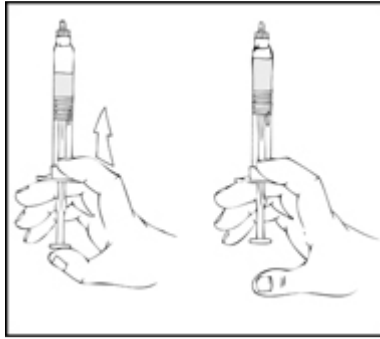

Note:

- If the solution is not to be used immediately, store the syringe upright, leaving the protective blue vent cap on the XYNTHA[®] SOLOFUSE[™] until ready to infuse.
- Store the reconstituted solution at room temperature prior to administration, but use within 3 hours after reconstitution or after removal of the grey rubber tip cap.
- XYNTHA, when reconstituted, contains polysorbate 80, which is known to increase the rate of di-(2-ethylhexyl) phthalate (DEHP) extraction from polyvinyl chloride (PVC). This should be considered during the preparation and administration of XYNTHA, including storage time elapsed in a PVC container following reconstitution. **The tubing of the infusion set included with this kit does not contain DEHP.**

2.3 Administration

For intravenous infusion after reconstitution only.

Inspect the final XYNTHA solution visually for particulate matter and discoloration prior to administration. The solution should be clear to slightly opalescent and colorless. If it is not, discard the solution and use a new kit.

Administer XYNTHA solution using the infusion set included in the kit. Do not administer reconstituted XYNTHA in the same tubing or container with other medicinal products.

1. After removing the protective blue vented cap, firmly attach the intravenous infusion set provided in the kit onto the XYNTHA[®] SOLOFUSE[™].

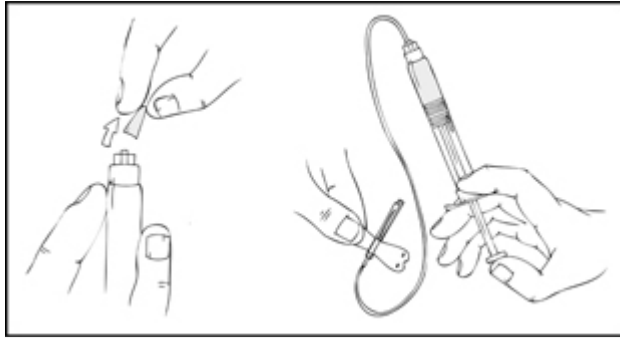

2. Apply a tourniquet and prepare the injection site by wiping the skin well with an alcohol swab provided in the kit.
3. Remove the protective needle cover and perform venipuncture. Insert the needle on the infusion set tubing into the vein, and remove the tourniquet. Verify proper needle placement.
4. Inject the reconstituted XYNTHA intravenously over several minutes. The rate of administration should be determined by the patient's comfort level.

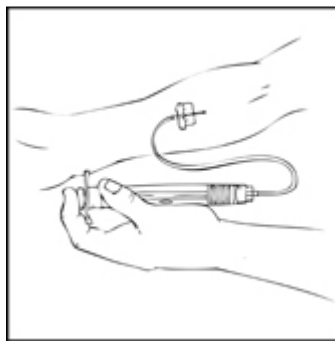

5. After infusing XYNTHA, remove and discard the infusion set. The amount of drug product left in the infusion set will not affect treatment.

Note: Dispose of all unused solution, the empty XYNTHA[®] SOLOFUSE[™], and other used medical supplies in an appropriate container.

2.4 Use of a XYNTHA Vial Kit with a XYNTHA[®] SOLOFUSE[™] Kit

These instructions are for the use of only one XYNTHA vial kit with one XYNTHA[®] SOLOFUSE[™] Kit. For further information, please contact the Medical Information Department at Wyeth Pharmaceuticals, 1-800-438-1985.

1. Reconstitute the XYNTHA vial using the instructions included with the product kit.
2. Detach the empty diluent syringe from the vial adapter by gently turning and pulling the syringe counterclockwise, leaving the contents in the vial and the vial adapter in place.



3. Reconstitute the XYNTHA[®] SOLOFUSE[™] using the instructions described in Preparation and Reconstitution [see *Dosage and Administration (2.2)*]. Remember to remove most, but not all, of the air from the drug product chamber.

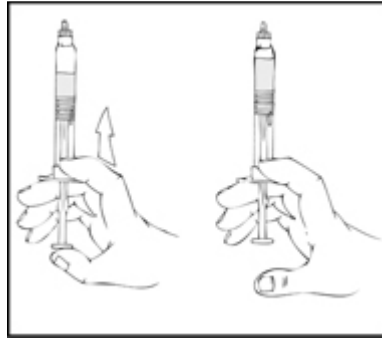

4. After removing the protective blue vented cap, connect the XYNTHA[®] SOLOFUSE[™] to the vial adapter by inserting the tip into the adapter opening while firmly pushing and turning the syringe clockwise until secured.

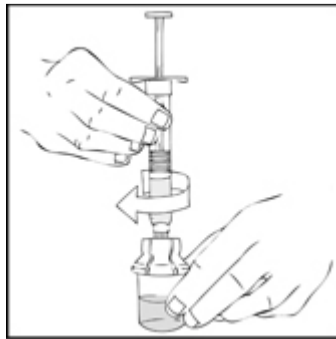

5. Slowly depress the plunger rod of the XYNTHA[®] SOLOFUSE[™] until the contents empty into the XYNTHA vial. The plunger rod may move back slightly after release.

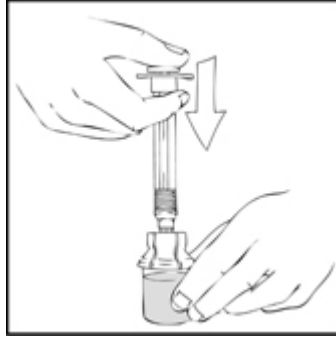

6. Detach and discard the empty XYNTHA[®] SOLOFUSE[™] from the vial adapter.
Note: If the syringe turns without detaching from the vial adapter, grasp the white collar and turn.



7. Connect a sterile 10 milliliter or larger luer lock syringe to the vial adapter. Inject some air into the vial to make withdrawing the vial contents easier.

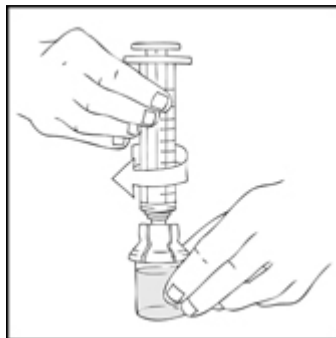

- Invert the vial and slowly draw the solution into the large luer lock syringe.

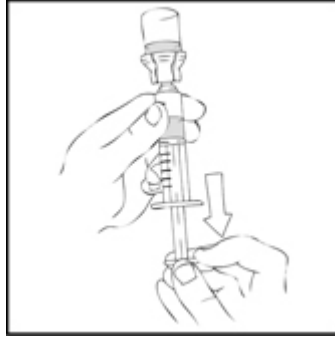

- Detach the syringe from the vial adapter by gently turning and pulling the syringe counterclockwise. Discard the empty XYNTHA vial with the adapter attached.
- Attach the infusion set to the large luer lock syringe as directed [*see Dosage and Administration (2.3)*].

2.5 Use of Multiple XYNTHA[®] SOLOFUSE[™] Kits

The instructions below are for the use of multiple XYNTHA[®] SOLOFUSE[™] kits with a 10 milliliter or larger luer lock syringe. For further information, please contact the Medical Information Department at Wyeth Pharmaceuticals, 1-800-438-1985.

Note: Luer-to-luer syringe connectors are not provided in these kits. Instruct patients to contact their XYNTHA supplier to order.

- Reconstitute all XYNTHA[®] SOLOFUSE[™] according to instructions described in Preparation and Reconstitution [*see Dosage and Administration (2.2)*].
- Holding the XYNTHA[®] SOLOFUSE[™] in an upright position, slowly advance the plunger rod until most, but not all, of the air is removed from the drug product chamber.

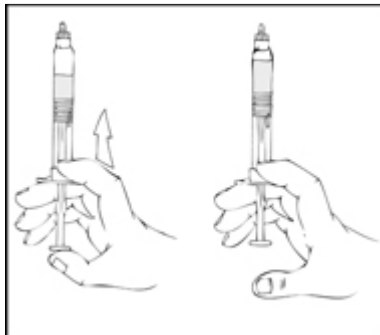

- Remove the luer-to-luer syringe connector from its package.
- After removing the protective blue vented cap, connect a sterile 10 milliliter or larger luer lock syringe to one opening (port) in the syringe connector and the XYNTHA[®]

SOLOFUSE™ to the remaining open port on the opposite end.

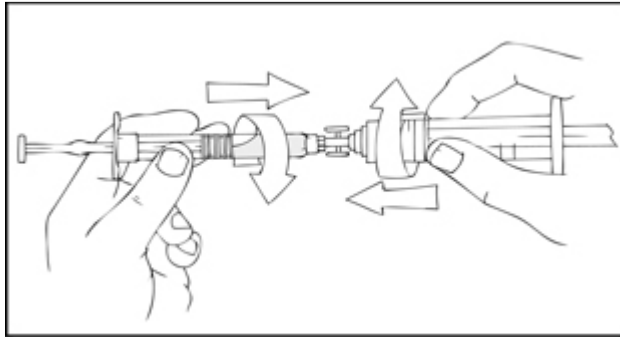

5. With the XYNTHA® SOLOFUSE™ on top, slowly depress the plunger rod until the contents empty into the large luer lock syringe.

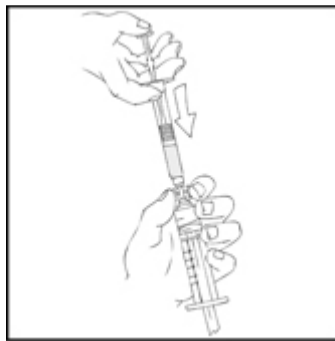

6. Remove the empty XYNTHA® SOLOFUSE™ and repeat procedures 3 and 4 above for any additional reconstituted XYNTHA SOLOFUSE.
7. Remove the luer-to-luer syringe connector from the large luer lock syringe and attach the infusion set as directed [*see Dosage and Administration (2.3)*].

3 DOSAGE FORMS AND STRENGTHS

XYNTHA SOLOFUSE is available as a white to off-white lyophilized powder in the following nominal dosages:

- 250 International Units
- 500 International Units
- 1000 International Units
- 2000 International Units
- 3000 International Units

Each XYNTHA SOLOFUSE has the actual recombinant factor VIII (rFVIII) potency in International Units stated on the label.

4 CONTRAINDICATIONS

XYNTHA is contraindicated in patients who have manifested life-threatening immediate hypersensitivity reactions, including anaphylaxis, to the product or its components, including hamster proteins.

5 WARNINGS AND PRECAUTIONS

5.1 Hypersensitivity Reactions

Allergic type hypersensitivity reactions, including anaphylaxis, are possible with XYNTHA. Inform patients of the early signs or symptoms of hypersensitivity reactions (including hives [rash with itching], generalized urticaria, chest tightness, wheezing, and hypotension) and anaphylaxis. Discontinue XYNTHA if hypersensitivity symptoms occur and administer appropriate emergency treatment.

XYNTHA contains trace amounts of hamster proteins. Patients treated with this product may develop hypersensitivity to these non-human mammalian proteins.

5.2 Neutralizing Antibodies

Inhibitors have been reported following administration of XYNTHA. Monitor patients for the development of factor VIII inhibitors by appropriate clinical observations and laboratory tests. If expected factor VIII activity plasma levels are not attained, or if bleeding is not controlled with an appropriate dose, perform an assay that measures factor VIII inhibitor concentration to determine if a factor VIII inhibitor is present [*see Warnings and Precautions (5.3)*].^{4,5,6,7,8,9,10,11,12}

5.3 Monitoring Laboratory Tests

- Use individual factor VIII values for recovery and, if clinically indicated, other pharmacokinetic characteristics to guide dosing and administration.
- Monitor plasma factor VIII activity levels by the one-stage clotting assay to confirm that adequate factor VIII levels have been achieved and are maintained, when clinically indicated [*see Dosage and Administration (2)*].
- Monitor for development of factor VIII inhibitors. Perform assay to determine if factor VIII inhibitor is present when expected factor VIII activity plasma levels are not attained, or when bleeding is not controlled with the expected dose of XYNTHA. Use Bethesda Units (BU) to titer inhibitors.

6 ADVERSE REACTIONS

The most common adverse reactions ($\geq 10\%$) with XYNTHA in adult and pediatric PTPs were headache, arthralgia, pyrexia, and cough.

6.1 Clinical Trials Experience

Because clinical trials are conducted under widely varying conditions, adverse reaction rates observed in the clinical trials of a drug cannot be directly compared to rates in the clinical trials of another drug and may not reflect the rates observed in clinical practice.

XYNTHA was evaluated in five clinical studies (N=155), four completed studies with adult and pediatric PTPs and one ongoing study in pediatric PTPs < 6 years of age.

The safety and efficacy of XYNTHA was evaluated in two completed pivotal studies. In the first study (n=94), safety and efficacy were examined in previously treated patients (PTPs) with hemophilia A (factor VIII activity in plasma [FVIII: C] $\leq 2\%$) who received XYNTHA for routine prophylaxis and on-demand treatment. Ninety-four subjects received at least one dose of XYNTHA, resulting in a total of 6,775 infusions [*see Clinical Studies (14)*]. The second study (n=30) examined the use of XYNTHA for surgical prophylaxis in previously treated patients with severe or moderately severe hemophilia A (FVIII: C $\leq 2\%$) who required elective major surgery and were expected to receive XYNTHA replacement therapy for at least 6 days post-surgery. All subjects received at least one dose of XYNTHA, resulting in 1161 infusions. One subject received XYNTHA for a pre-surgery pharmacokinetic assessment only and did not undergo surgery [*see Clinical Studies (14)*].

Across all studies, safety was evaluated in 48 previously treated pediatric patients <16 years of age (28 children, < 6 years of age and 20 adolescents, 12 to <16 years of age). A total of 7,150 infusions of XYNTHA were administered with a median dose per infusion of 29 IU/kg (min, max: 9,108 IU/kg).

Across all studies, the most common adverse reactions ($\geq 10\%$) with XYNTHA in adult and pediatric PTPs were headache (26% of subjects), arthralgia (25%), pyrexia (21%), cough (11%). Other adverse reactions reported in $\geq 5\%$ of subjects were: diarrhea (8%), vomiting (7%), asthenia (7%), and nausea (6%).

6.2 Immunogenicity

There is a potential for immunogenicity with therapeutic proteins. The development of factor VIII inhibitors with XYNTHA was evaluated in 144 adult and pediatric PTPs with at least 50 EDs. Laboratory-based assessments for FVIII inhibitor (partial Nijmegen modification of the Bethesda inhibitor assay) were conducted in the clinical studies. The criterion for a positive FVIII result test result was ≥ 0.6 BU/mL. Across all studies, 3 subjects developed factor VIII inhibitors (2.1%).

The clinical studies for XYNTHA examined 124 subjects (94 for bleeding and 30 for surgery) who had previously been treated with factor VIII (PTPs). In the safety and efficacy study, two subjects with inhibitors were observed in 89 subjects (2.2%) who completed ≥ 50 exposure days.

In a Bayesian statistical analysis, results from this study were used to update PTP results from a prior supporting study using XYNTHA manufactured at the initial facility (with one *de novo* and two recurrent inhibitors observed in 110 subjects) and the experience with predecessor product (with one inhibitor observed in 113 subjects). The Bayesian analysis indicated that the population inhibitor rate for XYNTHA, an estimate of the 95% upper limit of the true inhibitor rate, was 4.17%.

None of the PTPs developed anti-CHO (Chinese hamster ovary) or anti-TN8.2 antibodies. One PTP developed anti-FVIII antibodies; but, this subject did not develop an inhibitor.

In the surgery study, one low titer persistent inhibitor and one transient false-positive inhibitor were reported. In this study, one surgical subject developed anti-CHO cell antibodies with no associated allergic reaction. One subject developed anti-FVIII antibodies; but, this subject did not develop an inhibitor.

Across all studies, safety was evaluated in 40 previously treated pediatric patients <16 years of age with at least 50 EDs (25 children, <6 years of age and 15 adolescents, 12 to <16 years of age). Of these, one pediatric subject developed an inhibitor.

The detection of antibody formation is highly dependent on the sensitivity and specificity of the assay. Additionally, the observed incidence of antibody, including neutralizing antibody, positivity in an assay may be influenced by several factors, including assay methodology, sample handling, timing of sample collection, concomitant medications, and underlying disease. For these reasons, comparisons of the incidence of antibodies to XYNTHA with the incidence of antibodies to other products may be misleading.

6.3 Postmarketing Experience

Because these reactions are reported voluntarily from a population of uncertain size, it is not always possible to reliably estimate their frequency or establish a causal relationship to drug exposure.

The following postmarketing adverse reactions have been reported for XYNTHA:

Anaphylaxis

Inadequate therapeutic response

8 USE IN SPECIFIC POPULATIONS

8.1 Pregnancy

Pregnancy Category C. Animal reproduction studies have not been conducted with XYNTHA. It is not known whether XYNTHA can cause fetal harm when administered to a pregnant woman or can affect reproduction capacity. XYNTHA should be given to a pregnant woman only if clinically indicated.

8.2 Labor and Delivery

There is no information available on the effect of factor VIII replacement therapy on labor and delivery. XYNTHA should be used only if clinically indicated.

8.3 Nursing Mothers

It is not known whether this drug is excreted into human milk. Because many drugs are excreted into human milk, caution should be exercised if XYNTHA is administered to nursing mothers. XYNTHA should be given to nursing mothers only if clinically indicated.

8.4 Pediatric Use

In the completed open label safety and efficacy study of XYNTHA (n=94), 17 adolescent subjects 12 to <16 years of age with severe or moderately severe hemophilia A (FVIII:C \leq 2%), who were previously treated with at least 150 EDs to FVIII products, received XYNTHA for on-demand and follow-up treatment. The median dose per infusion was 47 IU/kg (min-max: 24-74) and the median exposure per subject was 6 days (min-max: 1-26).

Of the 17 subjects < 16 yrs of age who received at least 1 dose of XYNTHA, 10 subjects had bleeding episodes during the study. Among the 10 subjects with response assessments, a total of 66 bleeding episodes were treated with on-demand infusions of XYNTHA. The majority of the bleeding episodes (63/66 or 95.5%) resolved with 1 or 2 infusions. Thirty-eight (38) of 66 bleeding episodes (57.6%) were rated excellent or good in their response to initial treatment, 24 (36.4%) were rated as moderate and 4 (6.1%) were not rated.

Additional data are available from a safety and efficacy study of XYNTHA in children < 6 years of age with moderately severe or severe hemophilia A (FVIII:C \leq 2%) and with at least 20 prior EDs to FVIII products. In this study subjects received XYNTHA for on-demand and follow-up treatment of bleeding episodes. The median dose per infusion was 28 IU/kg and the median exposure per subject was 16 days.

Of the 27 subjects < 6 years of age who received at least 1 dose of XYNTHA, 25 had bleeding episodes during the study. Among the 24 subjects with response assessments there were 493 bleeds. The majority of the bleeding episodes (462/493 or 93.7%) resolved with 1 or 2 infusions. Subjects rated the outcomes of infusions on a pre-specified four (4) point hemostatic efficacy scale. Of 493 bleeding episodes treated with XYNTHA, 468 (94.9%) were rated excellent or good in their response to initial treatment and 22 (4.5%) were rated as moderate.

In comparison to the pharmacokinetic parameters reported in adults, children have shorter half-lives, larger volumes of distribution and lower recovery of factor VIII after XYNTHA administration. The clearance (based on per kg body weight) is approximately 40% higher in children. Higher or more frequent doses may be required to account for the observed differences in pharmacokinetic parameters. [see *Clinical Pharmacology* (12.3)]

8.5 Geriatric Use

Clinical studies of XYNTHA did not include subjects aged 65 and over. In general, dose selection for an elderly patient should be individualized.

11 DESCRIPTION

The active ingredient in XYNTHA, Antihemophilic Factor (Recombinant), is a recombinant antihemophilic factor (rAHF), also called coagulation factor VIII, which is produced by recombinant DNA technology. It is secreted by a genetically engineered Chinese hamster ovary (CHO) cell line. The cell line is grown in a chemically defined cell culture medium that contains recombinant insulin, but does not contain any materials derived from human or animal sources.

The rAHF in XYNTHA is a purified glycoprotein, with an approximate molecular mass of 170 kDa consisting of 1,438 amino acids, which does not contain the B-domain.¹³ The amino acid sequence of the rAHF is comparable to the 90 + 80 kDa form of human coagulation factor VIII.

The purification process uses a series of chromatography steps, one of which is based on affinity chromatography using a patented synthetic peptide affinity ligand.¹⁴ The process also includes a solvent-detergent viral inactivation step and a virus-retaining nanofiltration step.

The potency expressed in International Units (IU) is determined using the chromogenic assay of the European Pharmacopoeia. The Wyeth manufacturing reference standard for potency has been calibrated against the World Health Organization (WHO) International Standard for factor VIII activity using the one-stage clotting assay. The specific activity of XYNTHA is 5,500 to 9,900 IU per milligram of protein.

XYNTHA is formulated as a sterile, nonpyrogenic, no preservative, lyophilized powder preparation for intravenous injection. Each single-use prefilled dual-chamber syringe (named XYNTHA SOLOFUSE) contains nominally 250, 500, 1000, 2000, or 3000 IU of XYNTHA. Upon reconstitution, the product is a clear to slightly opalescent, colorless solution that contains sodium chloride, sucrose, L-histidine, calcium chloride and polysorbate 80.

12 CLINICAL PHARMACOLOGY

12.1 Mechanism of Action

XYNTHA temporarily replaces the missing clotting factor VIII that is needed for effective hemostasis.

12.2 Pharmacodynamics

The activated partial thromboplastin time (aPTT) is prolonged in patients with hemophilia. Determination of aPTT is a conventional *in vitro* assay for biological activity of factor VIII. Treatment with XYNTHA normalizes the aPTT over the effective dosing period.

12.3 Pharmacokinetics

The pharmacokinetic parameters of XYNTHA in 30 previously treated adult patients (PTP) 12 to 60 years old, who received a single infusion of 50 IU/kg XYNTHA are summarized in Table 3.

In addition, 25 of the same subjects later received a single infusion of 50 IU/kg of XYNTHA for a 6-month follow-up pharmacokinetic study. The parameters were comparable between baseline and 6 months, indicating no time-dependent changes in the pharmacokinetics of XYNTHA.

In a separate study, 8 of 30 subjects at least 12 years old with hemophilia A undergoing elective major surgery received a single 50 IU/kg infusion of XYNTHA. The pharmacokinetic parameters in these subjects are also summarized in Table 3.

Table 3: Mean ± SD XYNTHA Pharmacokinetic Parameters in Previously Treated Patients with Hemophilia A after Single 50 IU/kg Dose			
Parameter	Initial Visit (n = 30)	Month 6 (n = 25)	Pre-surgery (n=8)
C _{max} (IU/mL)	1.08 ± 0.22	1.24 ± 0.42	1.08 ± 0.24
AUC _∞ (IU·hr/mL)	13.5 ± 5.6	15.0 ± 7.5	16.0 ± 5.2
t _{1/2} (hr)	11.2 ± 5.0	11.8 ± 6.2*	16.7 ± 5.4
CL (mL/hr/kg)	4.51 ± 2.23	4.04 ± 1.87	3.48 ± 1.25
V _{ss} (mL/kg)	66.1 ± 33.0	67.4 ± 32.6	69.0 ± 20.1
Recovery (IU/dL per IU/kg)	2.15 ± 0.44	2.47 ± 0.84	2.17 ± 0.47
Abbreviations: AUC _∞ = area under the plasma concentration-time curve from zero to infinity; C _{max} = peak concentration; t _{1/2} = plasma elimination half-life; CL = clearance; n = number of subjects; SD = standard deviation; V _{ss} = volume of distribution at steady-state. *One subject was excluded from the calculation due to lack of a well-defined terminal phase.			

Table 4 shows the pharmacokinetic parameters of nine children; four aged 14 or 15 years of age, who are also included in the summary for the adults above, along with five children aged 3.7-5.8 years after single 50 IU/kg doses of XYNTHA. Compared to adults, the half-life of XYNTHA is shorter in children and the clearance (based on per kg body weight) is approximately 40% higher in children.

Table 4: Mean ± SD XYNTHA Pharmacokinetic Parameters in Previously Treated Pediatric Patients with Hemophilia A after Single 50 IU/kg Dose		
Parameter	Young Children (n=5)	Adolescents (n=4)
Age (min - max, yr))	3.7 - 5.8	14 - 15
C _{max} (IU/mL)	0.78 ± 0.34	0.97 ± 0.21
AUC _∞ (IU·hr/mL)	12.2 ± 6.50	8.5 ± 4.0
t _{1/2} (hr)	8.3 ± 2.7	6.9 ± 2.4
CL (mL/hr/kg)	6.29 ± 4.87	6.62 ± 2.16
V _{ss} (mL/kg)	66.9 ± 55.6	67.1 ± 13.6
Recovery (IU/dL per IU/kg)	1.52 ± 0.69	1.95 ± 0.41
Abbreviations: AUC _∞ = area under the plasma concentration-time curve from zero to infinity; C _{max} = peak concentration; t _{1/2} = plasma elimination half-life; CL = clearance; n = number of subjects; SD = standard deviation; V _{ss} = volume of distribution at steady-state.		

13 NONCLINICAL TOXICOLOGY

13.1 Carcinogenesis, Mutagenesis, Impairment of Fertility

No studies have been conducted with XYNTHA to assess its mutagenic or carcinogenic potential. XYNTHA has been shown to be comparable to the predecessor product with respect to its biochemical and physicochemical properties, as well as its nonclinical *in vivo* pharmacology and toxicology. By inference, predecessor product and XYNTHA would be expected to have equivalent mutagenic and carcinogenic potential. The predecessor product has been shown to be nongenotoxic in the mouse micronucleus assay. No studies have been conducted in animals to assess impairment of fertility or fetal development.

13.2 Animal Toxicology and/or Pharmacology

Preclinical studies evaluating XYNTHA in hemophilia A dogs without inhibitors demonstrated safe and effective restoration of hemostasis. XYNTHA demonstrated a toxicological profile that was similar to the toxicological profile observed with the predecessor product. Toxicity associated with XYNTHA was primarily associated with anti-FVIII neutralizing antibody generation first detectable at 15 days of repeat dosing in high (approximately 735 IU/kg/day) level-dosed, non-human primates.

14 CLINICAL STUDIES

Safety and Efficacy Study

In an open label safety and efficacy study (n=94), subjects received XYNTHA in a routine prophylaxis treatment regimen with on-demand treatment administered as clinically indicated. All 94 subjects were treated with at least one dose and all are included in the intent-to-treat (ITT) population. All subjects had been previously treated (previously treated patients or PTPs) with factor VIII. Eighty-nine (89) subjects accrued ≥ 50 exposure days (EDs). Median age for the 94 treated subjects was 24 years (mean 27.7 and range 12-60 years). All subjects had ≥ 150 previous exposure days with baseline FVIII activity level of ≤ 2%. Of the 94 subjects enrolled in this

study, 30 evaluable subjects participated in a randomized crossover pharmacokinetics study. Twenty-five (25/30) of these subjects with FVIII:C \leq 1% completed both the first (PK1) and the second (PK2) pharmacokinetic assessments [see *Clinical Pharmacology (12.3)*].¹⁶

For routine prophylaxis, XYNTHA was administered at a dose of 30 ± 5 IU/kg 3 times a week with provisions for dose escalation based on pre-specified criteria. Seven dose escalations were prescribed for 6 subjects during the course of the study. Forty-three subjects (43/94 or 45.7%) reported no bleeding while on routine prophylaxis. The median annualized bleeding rate (ABR) for all bleeding episodes was 1.9 (mean 3.9, range 0-42.1).

Fifty-three subjects (53/94) received XYNTHA on-demand treatment for a total of 187 bleeding episodes. Seven of these bleeding episodes occurred in subjects prior to switching to a prophylaxis treatment regimen. One hundred ten of 180 bleeds (110/180 or 61.1%) occurred \leq 48 hours after the last dose and 38.9% (70/180 bleeds) occurred $>$ 48 hours after the last dose. The majority of bleeds reported to occur \leq 48 hours after the last prophylaxis dose were traumatic (64/110 bleeds or 58.2%). Forty-two bleeds (42/70 or 60%) reported to occur $>$ 48 hours after the last prophylaxis dose were spontaneous. The on-demand treatment dosing regimen was determined by the investigator. The median dose for on-demand treatment was 30.6 IU/kg (range, 6.4 to 74.4 IU/kg).

The majority of bleeding episodes (173/187 or 92.5%) resolved with 1 or 2 infusions (Table 5). Subjects rated the outcomes of infusions on a pre-specified four (4) point hemostatic efficacy scale. One hundred thirty-two of 187 bleeding episodes (132/187 or 70.6%) treated with XYNTHA were rated excellent or good in their response to initial treatment, 45 (24.1%) were rated moderate. Five (2.7%) were rated no response, and 5 (2.7%) were not rated.

Response to 1st Infusion	Number of Infusions (%)					Total Number of Bleeds
	1	2	3	4	$>$ 4	
Excellent ^a	42 (95.5)	2 (4.5)	0 (0.0)	0 (0.0)	0 (0.0)	44
Good ^b	69 (78.4)	16 (18.2)	3 (3.4)	0 (0.0)	0 (0.0)	88
Moderate ^c	24 (53.3)	16 (35.6)	2 (4.4)	0 (0.0)	3 (6.7)	45
No Response ^d	0 (0.0)	0 (0.0)	2 (40.0)	2 (40.0)	1 (20.0)	5
Not Assessed	4 (80.0)	0 (0.0)	0 (0.0)	1 (20.0)	0 (0.0)	5 ^e
Total	139 (74.3)	34 (18.2)	7 (3.7)	3 (1.6)	4 (2.1)	187

^a *Excellent*: Definite pain relief and/or improvement in signs of bleeding starting within 8 hours after an infusion, with no additional infusion administered.

^b *Good*: Definite pain relief and/or improvement in signs of bleeding starting within 8 hours after an infusion, with at least one additional infusion administered for complete resolution of the bleeding episode.

^c *Moderate*: Probable or slight improvement starting after 8 hours following the infusion, with at least one additional infusion administered for complete resolution of the bleeding episode.

^d *No Response*: No improvement at all between infusions or during the 24 hour interval following an infusion, or condition worsens.

^e Includes one infusion with commercial FVIII that occurred before routine prophylaxis began.

Perioperative Management Study

In an open-label study (n=30) for surgical prophylaxis in subjects with hemophilia A, XYNTHA was administered to 25 efficacy-evaluable PTPs with severe or moderately severe (FVIII:C ≤ 2%) hemophilia A undergoing major surgical procedures (11 total knee replacements, 1 hip replacement, 5 synovectomies, 1 left ulnar nerve transposition release, 1 ventral hernia repair/scar revision, 1 knee arthroscopy, 1 revision and debridement of the knee after a total knee replacement, 1 hip arthroplasty revision, 1 stapes replacement, 1 ankle arthrodesis, and 1 pseudotumor excision).¹⁷

The results of the hemostatic efficacy ratings for these subjects are presented in Table 6. Investigator’s ratings of efficacy at the end of surgery and at the end of the initial postoperative period were “excellent” or “good” for all assessments. Intraoperative blood loss was reported as “normal” or “absent” for all subjects. Thirteen of the subjects (13/25 or 52%) had blood loss in the postoperative period. The postoperative blood loss was rated as “normal” for ten of these cases while three cases were rated “abnormal” (1 due to hemorrhage following surgical trauma to the epigastric artery, 1 due to an 800 mL blood loss after hip replacement surgery, and 1 after an elbow synovectomy where the blood loss could not be measured by the investigator).

Table 6: Summary of Hemostatic Efficacy			
Time of Hemostatic Efficacy Assessment	Excellent^a	Good^b	Number of subjects
End of surgery	18 (72%)	7 (28%)	25
End of initial postoperative period ^c	23 (92%)	2 (8%)	25

^a *Excellent* : Achieved hemostasis comparable to that expected after similar surgery in a patient without hemophilia.
^b *Good*: Prolonged time to hemostasis, with somewhat increased bleeding compared with that expected after similar surgery in a patient without hemophilia.
^c End of initial postoperative period is date of discharge or postoperative Day 6, whichever occurs later.

15 REFERENCES

1. Nilsson IM, Berntorp EE and Freiburghaus C. Treatment of patients with factor VIII and IX inhibitors. *Thromb Haemost.* 1993;70(1):56-59.
2. Hoyer LW. Hemophilia A. *N Engl J Med.* 1994;330:38-47.
3. Juhlin F. Stability and Compatibility of Reconstituted Recombinant Factor VIII SQ, 250 IU/ml, in a System for Continuous Infusion. Pharmacia Document 9610224, 1996.
4. Ehrenforth S, Kreuz W, Scharrer I, et al. Incidence of development of factor VIII and factor IX inhibitors in hemophiliacs. *Lancet.* 1992;339:594-598.
5. Lusher J, Arkin S, Abildgaard CF, Schwartz RS, the Kogenate PUP Study Group. Recombinant factor VIII for the treatment of previously untreated patients with hemophilia A. *N Engl J Med.* 1993;328:453-459.

6. Bray GL, Gomperts ED, Courter S, et al. A multicenter study of recombinant factor VIII (Recombinate): safety, efficacy, and inhibitor risk in previously untreated patients with hemophilia A. *Blood*. 1994;83(9):2428-2435.
7. Kessler C, Sachse K. Factor VIII:C inhibitor associated with monoclonal-antibody purified FVIII concentrate. *Lancet*. 1990;335:1403.
8. Schwartz RS, Abildgaard CF, Aledort LM, et al. Human recombinant DNA-derived antihemophilic factor (factor VIII) in the treatment of hemophilia A. *N Engl J Med*. 1990;323:1800-1805.
9. White GC II, Courter S, Bray GL, et al. A multicenter study of recombinant factor VIII (Recombinate™) in previously treated patients with hemophilia A. *Thromb Haemost*. 1997;77(4):660-667.
10. Gruppo R, Chen H, Schroth P, et al. Safety and immunogenicity of recombinant factor VIII (Recombinate™) in previously untreated patients: A 7.3 year update. *Haemophilia*. 1998;4:228 (Abstract No. 291, XXIII Congress of the WFH, The Hague).
11. Scharrer I, Bray GL, Neutzling O. Incidence of inhibitors in haemophilia A patients - a review of recent studies of recombinant and plasma-derived factor VIII concentrates. *Haemophilia*. 1999;5:145-154.
12. Abshire TC, Brackmann HH, Scharrer I, et al. Sucrose formulated recombinant human antihemophilic Factor VIII is safe and efficacious for treatment of hemophilia A in home therapy: Results of a multicenter, international, clinical investigation. *Thromb Haemost*. 2000;83(6):811-816.
13. Sandberg H, Almstedt A, Brandt J, Castro VM, Gray E, Holmquist L, et al. Structural and Functional Characterization of B-Domain Deleted Recombinant Factor VIII. *Sem Hematol*. 2001;38 (Suppl. 4):4-12.
14. Kelley BD, Tannatt M, Magnusson R, Hagelberg S. Development and Validation of an Affinity Chromatography Step Using a Peptide Ligand for cGMP Production of Factor VIII. *Biotechnol Bioeng*. 2004;87(3):400-412.
15. Mann KG and Ziedens KB. Overview of Hemostasis. In: Lee CA, Berntorp EE and Hoots WK, eds. *Textbook of Hemophilia*. USA, Blackwell Publishing; 2005:1-4.
16. Recht M, Nemes L, Matysiak M et al. Clinical Evaluation of Moroctocog Alfa (AF-CC), a New Generation of B-Domain Deleted Recombinant Factor VIII (BDDrFVIII) for Treatment of Haemophilia A: Demonstration of Safety, Efficacy and Pharmacokinetic Equivalence to Full-length Recombinant Factor VIII. *Haemophilia* 2009; 1-12.
17. Windyga J, Rusen L, Gruppo R, et al. BDDrFVIII (Moroctocog alfa [AF-CC]) for surgical haemostasis in patients with haemophilia A: results of a pivotal study. *Haemophilia*. 2010 Sep 1;16(5):731-9.

16 HOW SUPPLIED/STORAGE AND HANDLING

How Supplied

XYNTHA[®] SOLOFUSE[™] is supplied in a kit that includes the XYNTHA lyophilized powder containing nominally 250, 500, 1000, 2000 or 3000 IU and 4 mL 0.9 % Sodium Chloride solution for reconstitution in a prefilled dual-chamber syringe:

250 International Units Kit: NDC 58394-022-03

500 International Units Kit: NDC 58394-023-03

1000 International Units Kit: NDC 58394-024-03

2000 International Units Kit: NDC 58394-025-03

3000 International Units Kit: NDC 58394-016-03

Each XYNTHA[®] SOLOFUSE[™] Kit contains: one plunger rod for assembly, one sterile infusion set, two alcohol swabs, one bandage, one gauze pad, one vented sterile cap, and one package insert.

Actual factor VIII activity in International Units is stated on the label of each XYNTHA[®] SOLOFUSE[™].

Storage and Handling

Product as Packaged for Sale:

- Store XYNTHA[®] SOLOFUSE[™] under refrigeration at a temperature of 2° to 8°C (36° to 46°F) for up to 36 months from the date of manufacture until the expiration date stated on the label.
- Within the expiration date, XYNTHA[®] SOLOFUSE[™] also may be stored at room temperature not to exceed 25°C (77°F) for up to 3 months.
- Clearly record the starting date at room temperature storage in the space provided on the outer carton. At the end of the 3-month period, immediately use or discard the product. **Do not put the product back into the refrigerator.**
- Do not use XYNTHA[®] SOLOFUSE[™] after the expiration date stated on the label or after 3 months when stored at room temperature, whichever is earlier.
- Do not freeze. (Freezing may damage the XYNTHA[®] SOLOFUSE[™].)
- During storage, avoid prolonged exposure of XYNTHA[®] SOLOFUSE[™] to light.

- Store the reconstituted solution at room temperature prior to administration. Administer XYNTHA[®] SOLOFUSE[™] within 3 hours after reconstitution or after removal of the grey rubber tip cap from the product.

17 PATIENT COUNSELING INFORMATION

- Advise patients to read the FDA-approved patient labeling (Patient Information and Instructions for Use).
- Advise patients to report any adverse reactions or problems that concern them when taking XYNTHA to their healthcare provider.
- Allergic-type hypersensitivity reactions are possible. Discuss the early signs of hypersensitivity reactions (including hives [rash with itching], generalized urticaria, tightness of the chest, wheezing, hypotension) and anaphylaxis. Advise patients to discontinue use of the product, call their healthcare provider, and go to the emergency department if these symptoms occur.
- Advise patients to contact their healthcare provider if they experience a lack of a clinical response to factor VIII replacement therapy, as this may be a manifestation of an inhibitor.
- Advise patients to notify their healthcare provider if they become pregnant or intend to become pregnant during therapy, or if they are breastfeeding.
- Local irritation may occur when infusing XYNTHA SOLOFUSE.
- Advise patients to consult their healthcare provider prior to travel and to bring an adequate supply of XYNTHA SOLOFUSE, based on their current regimen, for anticipated treatment when traveling.

FDA-Approved Patient Labeling

Patient Information

XYNTHA[®] SOLOFUSE[™] /ZIN-tha/ [Antihemophilic Factor (Recombinant)]

Please read this patient information carefully before using XYNTHA and each time you get a refill. There may be new information. This leaflet does not take the place of talking with your healthcare provider about your medical problems or your treatment.

What is XYNTHA?

XYNTHA is an injectable medicine that is used to help control and prevent bleeding in people with hemophilia A. Hemophilia A is also called classic hemophilia. Your healthcare provider may give you XYNTHA when you have surgery.

XYNTHA is not used to treat von Willebrand's disease.

What should I tell my healthcare provider before using XYNTHA?

Tell your healthcare provider about all of your medical conditions, including if you:

- have any allergies, including allergies to hamsters.
- are pregnant or planning to become pregnant. It is not known if XYNTHA may harm your unborn baby.
- are breastfeeding. It is not known if XYNTHA passes into your milk and if it can harm your baby.

Tell your healthcare provider about all of the medicines you take, including all prescription and non-prescription medicines, such as over-the-counter medicines, supplements, or herbal remedies.

How should I infuse XYNTHA?

Step-by-step instructions for infusing with XYNTHA SOLOFUSE are provided at the end of this leaflet.

The steps listed below are general guidelines for using XYNTHA SOLOFUSE. Always follow any specific instructions from your healthcare provider. If you are unsure of the procedures, please call your healthcare provider before using.

Call your healthcare provider right away if bleeding is not controlled after using XYNTHA.

Your body can make antibodies against XYNTHA (called “inhibitors”) that may stop XYNTHA from working properly. Your healthcare provider may need to take blood tests from time to time to monitor for inhibitors.

Call your healthcare provider right away if you take more than the dose you should take.

Talk to your healthcare provider before traveling. Plan to bring enough XYNTHA SOLOFUSE for your treatment during this time.

What are the possible side effects of XYNTHA?

Call your healthcare provider or go to the emergency department right away if you have any of the following symptoms because these may be signs of a serious allergic reaction:

- wheezing
- difficulty breathing
- chest tightness
- turning blue (look at lips and gums)
- fast heartbeat

- swelling of the face
- faintness
- rash
- hives

Common side effects of XYNTHA are

- headache
- fever
- nausea
- vomiting
- diarrhea
- weakness

Talk to your healthcare provider about any side effect that bothers you or that does not go away. You may report side effects to FDA at 1-800-FDA-1088.

How should I store XYNTHA SOLOFUSE?

Store in the refrigerator at 36° to 46°F (2° to 8°C).

Do not freeze.

Protect from light.

XYNTHA[®] SOLOFUSE[™] can last at room temperature (below 77°F) for up to 3 months. If you store XYNTHA[®] SOLOFUSE[™] at room temperature, carefully write down the date you put XYNTHA[®] SOLOFUSE[™] at room temperature, so you will know when to throw it away. There is a space on the carton for you to write the date.

Throw away any unused XYNTHA SOLOFUSE after the expiration date.

Infuse within 3 hours after reconstitution or after removal of the grey rubber tip cap from the prefilled dual-chamber syringe. You can keep the reconstituted solution at room temperature before infusion for up to 3 hours. If it is not used in 3 hours, throw it away.

Do not use reconstituted XYNTHA if it is not clear to slightly opalescent and colorless.

Dispose of all materials, whether reconstituted or not, in an appropriate medical waste container.

What else should I know about XYNTHA?

Medicines are sometimes prescribed for purposes other than those listed here. Talk to your healthcare provider if you have any concerns. You can ask your healthcare provider for information about XYNTHA SOLOFUSE that was written for healthcare professionals.

Do not share XYNTHA SOLOFUSE with other people, even if they have the same symptoms that you have.

Instructions for Use

XYNTHA[®] SOLOFUSE[™] /ZIN-tha/ [Antihemophilic Factor (Recombinant)]

XYNTHA SOLOFUSE is supplied as a pre-filled dual-chamber syringe with lyophilized XYNTHA powder in one chamber and 0.9% sodium chloride solution in the other chamber. Before you can infuse it (intravenous injection), you must reconstitute the powder by mixing it with the sodium chloride solution.

Reconstitute and infuse XYNTHA[®] SOLOFUSE[™] using the infusion set provided in this kit. Please follow the directions below for the proper use of this product.

PREPARATION AND RECONSTITUTION OF XYNTHA[®] SOLOFUSE[™]

Preparation

1. Always wash your hands before doing the following steps.
2. Keep everything clean and germ-free while you are reconstituting XYNTHA[®] SOLOFUSE[™].
3. Once the syringes are open, finish reconstituting XYNTHA[®] SOLOFUSE[™] as soon as possible. This will help to keep them germ-free.
4. For additional instructions on the use of a XYNTHA[®] SOLOFUSE[™] and a XYNTHA vial or multiple XYNTHA[®] SOLOFUSE[™], see the detailed information provided after **INFUSION OF XYNTHA** section.

Reconstitution

1. Allow the XYNTHA SOLOFUSE to reach room temperature.
2. Remove the contents of the XYNTHA[®] SOLOFUSE[™] Kit and place on a clean surface, making sure you have all the supplies you will need.
3. Grasp the plunger rod as shown in the following diagram. Do not touch the shaft of the plunger rod. Screw the plunger rod firmly into the opening in the finger rest of the XYNTHA[®] SOLOFUSE[™] by pushing and turning firmly until resistance is felt (approximately 2 turns).

Throughout the reconstitution process, it is important to keep the XYNTHA[®] SOLOFUSE[™] upright to prevent possible leakage.

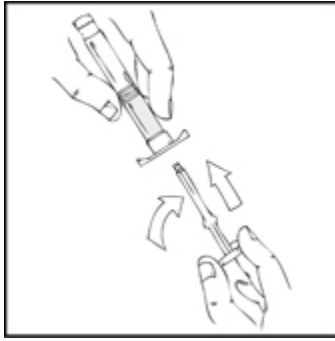

4. Holding the XYNTHA[®] SOLOFUSE[™] upright, remove the white tamper-evident seal by bending the seal right to left (or a gentle rocking motion) to break the perforation of the cap and expose the grey rubber tip cap of the XYNTHA[®] SOLOFUSE[™].

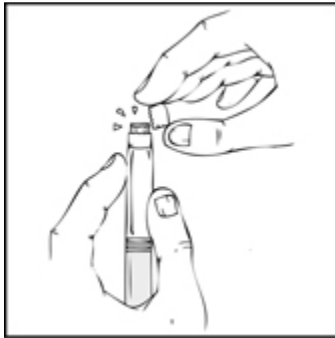

5. Remove the protective blue vented sterile cap from its package. While holding the XYNTHA[®] SOLOFUSE[™] upright, remove the grey rubber tip cap and replace it with the protective blue vented cap (prevents pressure build-up). Avoid touching the open end of both the syringe and the protective blue vented cap.

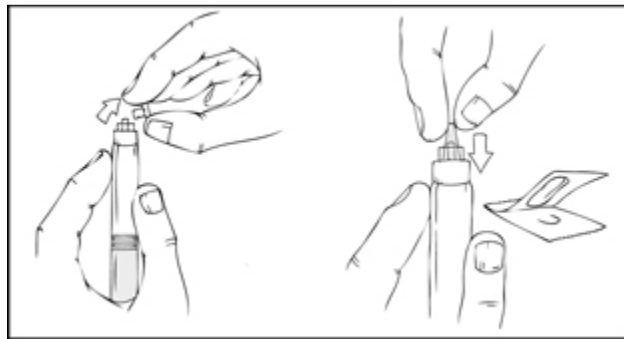

6. **Gently and slowly** push the plunger rod until the two stoppers inside the XYNTHA[®] SOLOFUSE[™] meet, and all of the diluent is transferred to the chamber containing the XYNTHA powder.

Note: To prevent the escape of fluid from the tip of the syringe, do not push the plunger rod with excessive force.

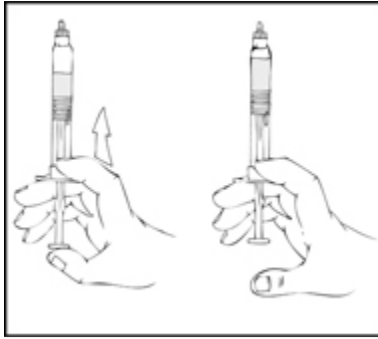

7. With the XYNTHA[®] SOLOFUSE[™] remaining upright, swirl **gently** several times until the powder is dissolved.

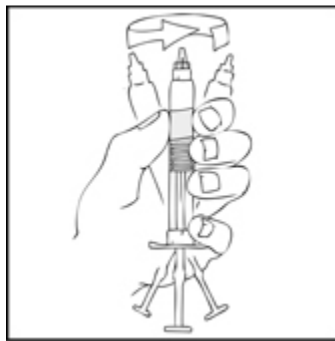

Look carefully at the solution in the XYNTHA[®] SOLOFUSE[™]. The solution should be clear to slightly opalescent and colorless. If it is not, throw away the solution and use a new kit.

8. Holding the XYNTHA[®] SOLOFUSE[™] in an upright position, slowly advance the plunger rod until most, but not all, of the air is removed from the drug product chamber.

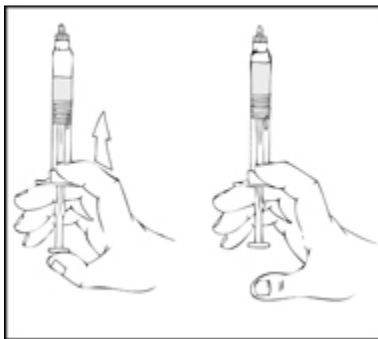

Note:

- If you are not using the solution immediately, store the syringe upright and keep the protective blue vent cap on the XYNTHA[®] SOLOFUSE[™] until ready to infuse.
- Infuse XYNTHA solution within 3 hours after reconstitution or removal of the grey tip cap from the XYNTHA SOLOFUSE. The reconstituted solution may be kept at room temperature for up to 3 hours prior to infusion. If you have not used it in 3 hours, throw it away.
- If more than one XYNTHA[®] SOLOFUSE[™] is needed for each infusion, a luer-to-luer syringe connector can be used (not included in this kit). Please contact your doctor or healthcare provider, or call the Wyeth Medical Information Department at 1-800-438-1985, for additional information.

INFUSION OF XYNTHA

Your healthcare provider will teach you how to infuse XYNTHA yourself. Once you learn how to do this, you can follow the instructions in this insert.

Before XYNTHA can be infused, you must reconstitute it as instructed above in the **PREPARATION AND RECONSTITUTION OF XYNTHA SOLOFUSE** section.

After reconstitution, be sure to look carefully at the XYNTHA solution. The solution should be clear to slightly opalescent and colorless. If it is not, throw away the solution and use a new kit.

Use the infusion set included in the kit to infuse XYNTHA. Do not infuse XYNTHA in the same tubing or container with other medicines.

1. After removing the protective blue vented cap, firmly attach the intravenous infusion set provided in the kit onto the XYNTHA[®] SOLOFUSE[™].

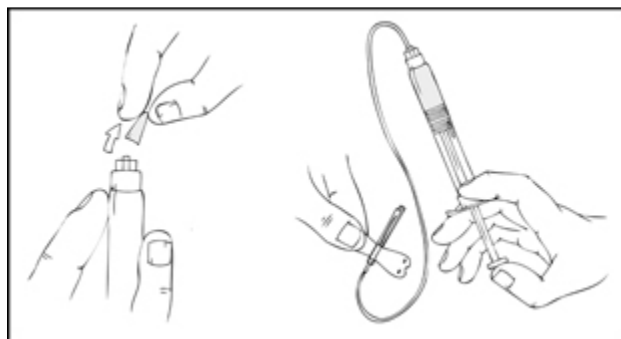

2. Apply a tourniquet and prepare the injection site by wiping the skin well with an alcohol swab provided in the kit.

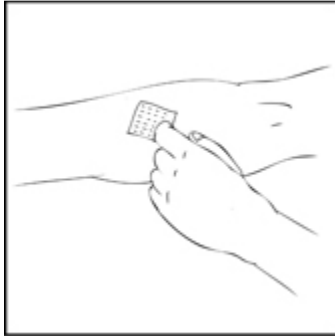

3. Remove the protective needle cover and insert the butterfly needle of the infusion set tubing into your vein as instructed by your healthcare provider. Remove the tourniquet. Verify proper needle placement.
4. Infuse the reconstituted XYNTHA product over several minutes. Your comfort level should determine the rate of infusion.

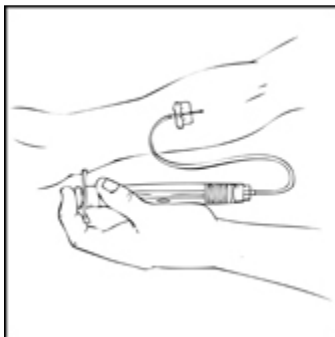

5. After infusing XYNTHA, remove the infusion set and throw it away. The amount of liquid left in the infusion set will not affect your treatment.

Note:

- Throw away all unused solution, the empty XYNTHA[®] SOLOFUSE[™], and other used medical supplies in an appropriate container.



- It is a good idea to record the lot number from the XYNTHA[®] SOLOFUSE[™] label every time you use XYNTHA. You can use the peel-off label found on the XYNTHA[®] SOLOFUSE[™] to record the lot number.

ADDITIONAL INSTRUCTIONS

XYNTHA is also supplied in kits that include single-use vials with lyophilized powder and prefilled diluent syringes.

If you use one XYNTHA vial and one XYNTHA[®] SOLOFUSE[™] for the infusion, reconstitute the XYNTHA vial and the XYNTHA SOLOFUSE[™] according to the specific directions for that respective product kit. Use a separate, 10 milliliter or larger luer lock syringe (not included in this kit) to draw back the reconstituted contents of the XYNTHA vial and the XYNTHA[®] SOLOFUSE[™].

If you use multiple XYNTHA[®] SOLOFUSE[™] kits for the infusion, reconstitute each XYNTHA[®] SOLOFUSE[™] according to the directions above. Use a separate, 10 milliliter or larger luer lock syringe (not included in this kit) to draw back the reconstituted contents of any additional XYNTHA[®] SOLOFUSE[™].

Use of a XYNTHA Vial Kit with a XYNTHA[®] SOLOFUSE[™] Kit

These instructions are for the use of only one XYNTHA vial kit with one XYNTHA[®] SOLOFUSE[™] Kit. For further information, please contact your healthcare provider or call the Medical Information Department at Wyeth Pharmaceuticals, 1-800-438-1985.

1. Reconstitute the XYNTHA vial using the instructions included with the kit. Detach the empty diluent syringe from the vial adapter by gently turning and pulling the syringe counterclockwise, leaving the contents in the XYNTHA vial with the vial adapter in place.



2. Reconstitute the XYNTHA[®] SOLOFUSE[™] using the instructions included with the product kit, remembering to remove most, but not all, of the air from the syringe.

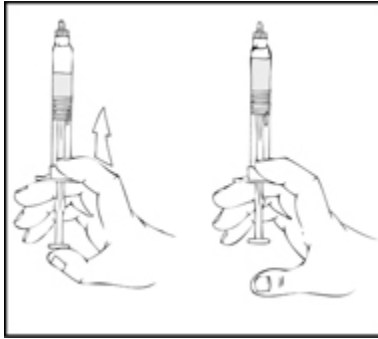

3. After removing the protective blue vented cap, connect the XYNTHA[®] SOLOFUSE[™] to the vial adapter by inserting the tip into the adapter opening while firmly pushing and turning the syringe clockwise until secured.



4. Slowly push the plunger rod of the XYNTHA[®] SOLOFUSE[™] to empty the contents into the XYNTHA vial. The plunger rod may move back slightly after release.

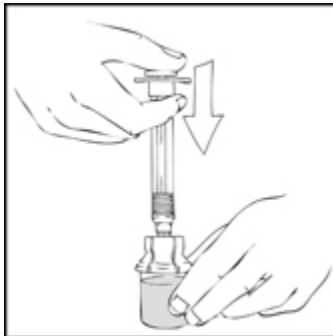

5. Detach the empty XYNTHA[®] SOLOFUSE[™] from the vial adapter and throw it away. If the syringe turns without detaching from the vial adapter, grasp the white collar and turn.



6. Connect a sterile 10 milliliter or larger luer lock syringe to the vial adapter. You may want to inject some air into the vial to make withdrawing the vial contents easier.

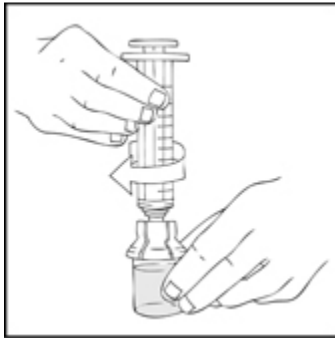

7. Invert the XYNTHA vial and slowly draw the solution into the large luer lock syringe.

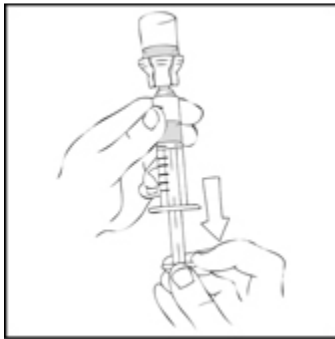

8. Detach the large luer lock syringe from the vial adapter by gently turning and pulling the syringe counterclockwise. Throw away the empty XYNTHA vial with the adapter attached.

9. Attach the infusion set to the large luer lock syringe as directed in the **INFUSION OF XYNTHA** section.

Note: Dispose of all unused solution, the empty XYNTHA[®] SOLOFUSE[™], and other used medical supplies in an appropriate container.



Use of Multiple XYNTHA[®] SOLOFUSE[™] Kits

The instructions below are for the use of multiple XYNTHA[®] SOLOFUSE[™] kits with a 10 milliliter or larger luer lock syringe. For further information, please contact your healthcare provider or call the Medical Information Department at Wyeth Pharmaceuticals, 1-800-438-1985.

Note: Luer-to-luer syringe connectors are not provided in the kits. Contact your XYNTHA supplier to order.

1. Reconstitute all XYNTHA[®] SOLOFUSE[™] according to instructions described in **PREPARATION AND RECONSTITUTION OF XYNTHA[®] SOLOFUSE[™]** section. Holding the XYNTHA[®] SOLOFUSE[™] in an upright position, slowly push the plunger rod until most, but not all, of the air is removed from the syringe.

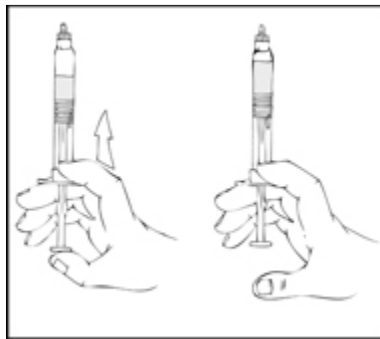

2. Remove the luer-to-luer syringe connector from its package.
3. After removing the protective blue vented cap, connect a sterile 10 milliliter or larger luer lock syringe to one opening (port) in the syringe connector and the XYNTHA[®] SOLOFUSE[™] to the remaining open port on the opposite end.

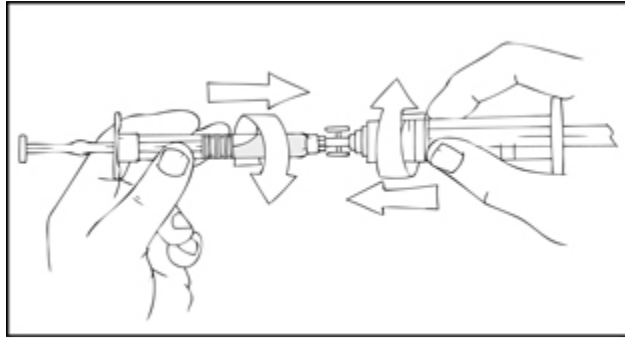

4. With the XYNTHA[®] SOLOFUSE[™] on top, slowly push the plunger rod to empty all the XYNTHA SOLOFUSE content into the large luer lock syringe.

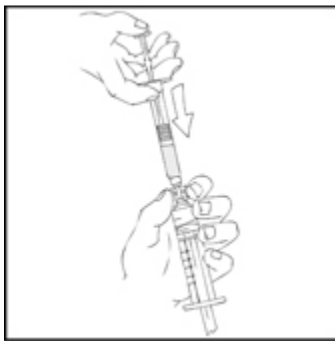

5. Remove the empty XYNTHA[®] SOLOFUSE[™] and repeat procedures 3 and 4 above for any additional XYNTHA[®] SOLOFUSE[™].
6. Remove the luer-to-luer syringe connector from the large luer lock syringe and attach the infusion set as directed in the **INFUSION OF XYNTHA** section.

Note: Dispose of all unused solution, the empty XYNTHA[®] SOLOFUSE[™], and other used medical supplies in an appropriate container.

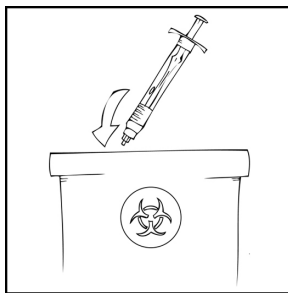



Manufactured by

Wyeth Pharmaceuticals Inc

A subsidiary of Pfizer Inc, Philadelphia, PA 19101

License no: 3
LAB-0500-9.0