

PRODUCT MONOGRAPH  
INCLUDING PATIENT MEDICATION INFORMATION

Xyntha®

Antihemorrhagic Blood Coagulation Factor VIII

Lyophilized Powder for Reconstitution in a Vial

250, 500, 1000, or 2000 IU in single-use vials and one pre-filled diluent syringe containing 4 mL 0.9% Sodium Chloride for reconstitution\*

and

Xyntha® Solofuse™

Antihemorrhagic Blood Coagulation Factor VIII

Lyophilized Powder for Reconstitution in a Prefilled Dual-Chamber Syringe

250, 500, 1000, 2000, or 3000 IU and 4 mL 0.9 % Sodium Chloride solution for reconstitution in a prefilled dual-chamber syringe

Antihemophilic Factor (Recombinant) [BDDrFVIII]

®T.M. Wyeth LLC  
Pfizer Canada ULC, Licensee  
17,300 Trans-Canada Highway  
Kirkland, Quebec  
H9J 2M5

Date of Initial Authorization:  
May 28, 2002  
Date of Revision:  
November 17, 2022

Submission Control Number: 259169

©Pfizer Canada ULC

## RECENT MAJOR LABEL CHANGES

7 WARNINGS AND PRECAUTIONS, 7.1.3 Pediatrics	10/2022
8 ADVERSE REACTIONS, 8.2 Clinical Trial Adverse Reactions	10/2022
8 ADVERSE REACTIONS, 8.2 Clinical Trial Adverse Reactions - Pediatrics	10/2022
10 CLINICAL PHARMACOLOGY, 10.1 Mechanism of Action	10/2022
10 CLINICAL PHARMACOLOGY, 10.3 Pharmacokinetics	10/2022
14 CLINICAL TRIALS, 14.1 Clinical Trials by indication	10/2022

## TABLE OF CONTENTS

Sections or subsections that are not applicable at the time of authorization are not listed.

<b>RECENT MAJOR LABEL CHANGES</b> .....	<b>2</b>
<b>TABLE OF CONTENTS</b> .....	<b>2</b>
<b>PART I: HEALTH PROFESSIONAL INFORMATION</b> .....	<b>4</b>
<b>1 INDICATIONS</b> .....	<b>4</b>
1.1 Pediatrics .....	4
1.2 Geriatrics.....	4
<b>2 CONTRAINDICATIONS</b> .....	<b>4</b>
<b>3 SERIOUS WARNINGS AND PRECAUTIONS BOX</b> .....	<b>4</b>
<b>4 DOSAGE AND ADMINISTRATION</b> .....	<b>4</b>
4.1 Dosing Considerations .....	4
4.2 Recommended Dose and Dosage Adjustment.....	5
4.3 Reconstitution.....	6
4.4 Administration .....	7
4.5 Missed Dose.....	18
<b>5 OVERDOSAGE</b> .....	<b>18</b>
<b>6 DOSAGE FORMS, STRENGTHS, COMPOSITION AND PACKAGING</b> .....	<b>18</b>
<b>7 WARNINGS AND PRECAUTIONS</b> .....	<b>18</b>
7.1 Special Populations.....	19
7.1.1 Pregnant Women .....	19
7.1.2 Breast-feeding.....	19
7.1.3 Pediatrics.....	19
7.1.4 Geriatrics.....	20

<b>8</b>	<b>ADVERSE REACTIONS.....</b>	<b>20</b>
8.1	Adverse Reaction Overview.....	20
8.2	Clinical Trial Adverse Reactions.....	20
	8.2.1 Clinical Trial Adverse Reactions – Pediatrics.....	23
8.5	Post-Market Adverse Reactions .....	23
<b>9</b>	<b>DRUG INTERACTIONS .....</b>	<b>23</b>
9.4	Drug-Drug Interactions .....	23
9.5	Drug-Food Interactions.....	23
9.6	Drug-Herb Interactions.....	23
9.7	Drug-Laboratory Test Interactions .....	23
<b>10</b>	<b>CLINICAL PHARMACOLOGY .....</b>	<b>23</b>
10.1	Mechanism of Action.....	23
10.2	Pharmacodynamics.....	24
10.3	Pharmacokinetics.....	24
<b>11</b>	<b>STORAGE, STABILITY AND DISPOSAL.....</b>	<b>27</b>
<b>12</b>	<b>SPECIAL HANDLING INSTRUCTIONS.....</b>	<b>27</b>
	<b>PART II: SCIENTIFIC INFORMATION .....</b>	<b>28</b>
<b>13</b>	<b>PHARMACEUTICAL INFORMATION.....</b>	<b>28</b>
<b>14</b>	<b>CLINICAL TRIALS .....</b>	<b>29</b>
	14.1 Clinical Trials by Indication .....	29
	14.2 Study Results.....	31
<b>15</b>	<b>MICROBIOLOGY.....</b>	<b>33</b>
<b>16</b>	<b>NON-CLINICAL TOXICOLOGY .....</b>	<b>33</b>
	<b>PATIENT MEDICATION INFORMATION .....</b>	<b>38</b>

## **PART I: HEALTH PROFESSIONAL INFORMATION**

### **1 INDICATIONS**

Xyntha, Antihemophilic Factor (Recombinant) [BDDrFVIII] is indicated for:

- the control and prevention of hemorrhagic episodes
- routine and surgical prophylaxis in patients with hemophilia A (congenital factor VIII deficiency or classic hemophilia).

Xyntha does not contain von Willebrand factor and hence is not indicated in von Willebrand's disease.

#### **1.1 Pediatrics**

Xyntha is appropriate for use in children of all ages, including newborns.

#### **1.2 Geriatrics**

Clinical studies of Xyntha did not include sufficient numbers of subjects aged 65 and over to determine whether they respond differently from younger subjects. Other reported clinical experience has not identified differences in responses between the elderly and younger patients. As with any patient receiving Xyntha, dose selection for an elderly patient should be individualized.

### **2 CONTRAINDICATIONS**

- Xyntha may be contraindicated in patients with a known hypersensitivity to any of the constituents of the preparation (**see 6 DOSAGE FORMS, STRENGTHS, COMPOSITION AND PACKAGING**).
- Xyntha has not been studied in patients with a known history of hypersensitivity to hamster proteins and may be contraindicated in these patients.

### **3 SERIOUS WARNINGS AND PRECAUTIONS BOX**

#### **Serious Warnings and Precautions**

- Anaphylaxis and severe hypersensitivity reactions are possible as with any intravenous protein product. Should such reactions occur, treatment with the product should be discontinued and appropriate treatment should be administered.
- Development of activity-neutralizing antibodies has been detected in patients receiving factor VIII-containing products. If expected plasma factor VIII activity levels are not attained, or if bleeding is not controlled with an appropriate dose, an assay that measures factor VIII inhibitor concentration should be performed.

### **4 DOSAGE AND ADMINISTRATION**

#### **4.1 Dosing Considerations**

- Treatment with Xyntha should be initiated under the supervision of a health professional experienced in the treatment of hemophilia A.
- Xyntha is appropriate for use in adults and children including newborns.
- Dosage and duration of treatment depend on the severity of the factor VIII deficiency, the location and extent of bleeding, and the patient's clinical condition. Individual patients may vary in their

response to factor VIII, achieving different levels of in vivo recovery and demonstrating different half-lives. Doses administered should be titrated to the patient’s clinical response. In the presence of an inhibitor, higher doses or appropriate alternative treatment may be required. Dosage adjustment for patients with renal or hepatic impairment has not been studied in clinical trials.

- The number of units of factor VIII administered is expressed in International Units (IU), which are related to the current World Health Organization (WHO) international standard for factor VIII activity. Factor VIII activity in plasma is expressed either as a percentage (relative to normal human plasma) or in IU (relative to an International Standard for factor VIII in plasma).
- One IU of factor VIII activity corresponds approximately to the quantity of factor VIII in one mL of normal human plasma. The calculation of the required dosage of factor VIII is based upon the empirical finding that, on average, 1 IU of factor VIII per kg body weight raises the plasma factor VIII activity by 2 IU/dL. The required dosage is determined using the following formula:

$$\text{Required units} = \text{body weight (kg)} \times \text{desired factor VIII rise (IU/dL or \% of normal)} \times 0.5 \text{ (IU/kg per IU/dL)}$$

- Clinical data support the use of the one-stage clotting assay for monitoring Xyntha therapy.
- The labeled potency of Xyntha is based on the European Pharmacopoeia chromogenic substrate assay in which the Pfizer In-House Recombinant Factor VIII Potency Reference Standard has been calibrated using a one-stage clotting assay. This method of potency assignment is intended to harmonize Xyntha with clinical monitoring using a one-stage clotting assay.
- Precise monitoring of the replacement therapy by means of plasma factor VIII activity assay should be considered, particularly for surgical intervention.

#### 4.2 Recommended Dose and Dosage Adjustment

##### **Dosing for Bleeding and Surgery:**

In the case of the following hemorrhagic events, consideration should be given to maintaining the factor VIII activity at or above the plasma levels (in % of normal or in IU/dL) for the indicated period, as outlined in the following table.

**Table 1: Maintenance of Factor VIII Activity for Various Hemorrhagic Events**

Type of Hemorrhage	Factor VIII Level Required (% or IU/dL)	Frequency of Doses (h)/ Duration of Therapy (d)
Minor Early hemarthrosis, superficial muscle or soft tissue and oral bleeds	20-40	Repeat every 12 to 24 hours as necessary until resolved. At least 1 day, depending upon the severity of the hemorrhage.
Moderate Hemorrhages into muscles. Mild head	30-60	Repeat infusion every 12 - 24 hours for 3 - 4 days or until adequate hemostasis is achieved. For tooth extraction a single

**Table 1: Maintenance of Factor VIII Activity for Various Hemorrhagic Events**

Type of Hemorrhage	Factor VIII Level Required (% or IU/dL)	Frequency of Doses (h)/ Duration of Therapy (d)
trauma capitus. Minor operations including tooth extraction. Hemorrhages into the oral cavity.		infusion plus oral antifibrinolytic therapy within 1 hour may be sufficient.
Major Gastrointestinal bleeding. Intracranial, intra-abdominal or intrathoracic hemorrhages. Fractures. Major operations.	60-100	Repeat infusion every 8 - 24 hours until threat is resolved or in the case of surgery, until adequate local hemostasis is achieved, then continue therapy for at least another 7 days.

**Dosage for Prophylaxis**

Xyntha has been administered prophylactically in a pivotal clinical trial in adolescent and adult previously treated patients at a dose of  $30 \pm 5$  IU/kg given 3 times weekly.

**Inhibitors**

Patients using factor VIII replacement therapy should be monitored for the development of factor VIII inhibitors. If expected factor VIII activity plasma levels are not attained, or if bleeding is not controlled with an appropriate dose, an assay should be performed to determine if a factor VIII inhibitor is present. In patients with factor VIII inhibitors, factor VIII therapy may not be effective and other therapeutic options should be considered. Management of such patients should be directed by health professionals with experience in the care of patients with hemophilia.

**4.3 Reconstitution**

Always wash your hands before performing the following procedures. Use germ-free methods during the preparation procedures.

All components used in the mixing and injection of Xyntha should be used as soon as possible after opening their sterile containers to minimize unnecessary exposure to room air.

**Xyntha Vial Kit:**

Use only the materials provided in the Xyntha kit for dissolving the Xyntha powder with the sodium chloride diluent.

Xyntha is administered by intravenous injection after dissolving with the supplied diluent (0.9% sodium chloride) in the pre-filled syringe.

**Note:** If you use more than one vial of Xyntha per injection, each vial should be dissolved according to the following instructions. The empty syringe should be removed leaving the vial adapter in place, and a separate large luer lock syringe may be used to draw back the dissolved contents of each vial. Do not

detach the diluent syringes or the large luer lock syringe until you are ready to attach the large luer lock syringe to the next vial adapter.

**Xyntha Solofuse:**

**Note:** If you use more than one vial and/or prefilled dual-chamber syringe of Xyntha per infusion, each vial and/or syringe should be reconstituted according to the instructions for that respective product kit. A separate 10 cc or larger luer lock syringe (not included in this kit) may be used to draw back the reconstituted contents of each vial or syringe.

**4.4 Administration**

Patients should follow the specific reconstitution and administration procedures provided by their health professionals. For instructions, patients should follow the recommendations in the below **Administration** and **Reconstitution** sections. The procedures below are provided as general guidelines for the reconstitution and administration of Xyntha.

Additional instructions are provided after **Infusion** section that detail the use of a Xyntha vial and a Xyntha **Solofuse** or multiple Xyntha **Solofuse** [see Combined Use of a Xyntha Vial Kit and a Xyntha **Solofuse**, and Multiple Xyntha **Solofuse** Reconstitution to a 10 cc or Larger Luer Lock Syringe].

Parenteral drug products should be inspected visually for particulate matter and discoloration prior to administration, whenever solution and container permit.

**Xyntha Vial Kit:**

Xyntha is administered by intravenous (IV) infusion after reconstitution of the lyophilized powder with the supplied pre-filled diluent (0.9% Sodium Chloride solution) syringe.

**Xyntha Solofuse:**

Xyntha Solofuse is administered by IV infusion after reconstitution of the freeze-dried powder with the diluent (0.9% Sodium Chloride). Both the Xyntha powder and the diluent are supplied within the prefilled dual-chamber syringe.

**Xyntha Vial Kit:**

1. Allow the vial of freeze-dried Xyntha powder and the pre-filled diluent syringe to reach room temperature.
2. Remove the plastic flip-top cap from the Xyntha vial to expose the central portions of the rubber stopper.

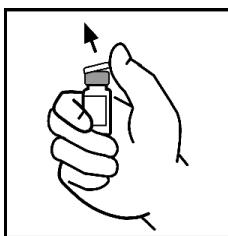

3. Wipe the top of the vial with the alcohol swab provided, or use another antiseptic solution, and allow to dry. After cleaning, do not touch the rubber stopper with your hand or allow it to touch any surface
4. Peel back the cover from the clear plastic vial adapter package. **Do not remove the adapter from the package.**
5. Place the vial on a flat surface. While holding the adapter in the package, place the vial adapter over the vial. Press down firmly on the package until the adapter snaps into place on top of the vial, with the adapter spike penetrating the vial stopper.

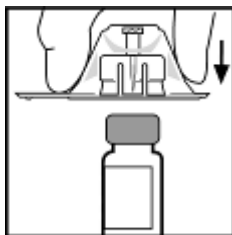

6. Break off the tamper-resistant, plastic-tip cap from the diluent syringe by snapping the perforation of the cap. This is done by bending the cap up and down until the perforation is broken. Do not touch the inside of the cap or the syringe tip. The diluent syringe may need to be recapped (if the dissolved Xyntha is not used immediately), so place the cap on its top on a clean surface in a spot where it would be least likely to become contaminated.

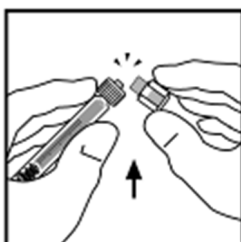

7. Grasp the plunger rod as shown in the diagram. Avoid contact with the shaft of the plunger rod. Attach the threaded end of the plunger rod to the diluent syringe by pushing and turning firmly.



8. Lift the package away from the adapter and discard the package.



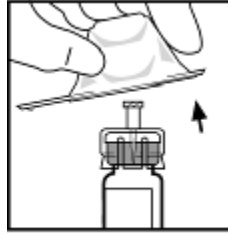

9. Place the vial on a flat surface. Connect the diluent syringe to the vial adapter by inserting the tip of the syringe into the adapter opening while firmly pushing and turning the syringe clockwise until the connection is secured.

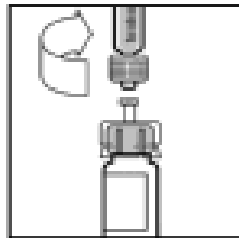

10. Slowly depress the plunger rod to inject all the diluent into the Xyntha vial.

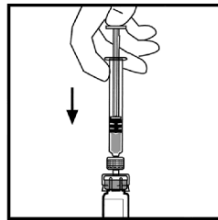

11. Ensuring that the syringe plunger rod is still fully depressed, invert the vial. Slowly draw the solution into the syringe.

Note: If you prepared more than one vial of Xyntha, remove the diluent syringe from the vial adapter, leaving the vial adapter attached to the vial. Quickly attach a separate large luer lock syringe and draw back the dissolved contents as instructed above. Repeat this procedure with each vial in turn. Do not detach the diluent syringes or the large luer lock syringe until you are ready to attach the large luer lock syringe to the next vial adapter.

12. With the syringe still connected to the adapter, gently swirl the contents of the vial until the powder is dissolved.

Note: The final solution should be inspected visually for particulate matter before administration. The solution should be clear to slightly pearly and colorless. If it is not, the solution should be discarded and a new kit should be used.

13. Detach the syringe from the vial adapter by gently pulling and turning the syringe counterclockwise. Discard the vial with the adapter attached.

Note: If the solution is not to be used immediately, the syringe cap should be carefully replaced. Do not touch the syringe tip or the inside of the cap.

Xyntha should be infused within 3 hours after dissolving. The dissolved solution may be stored at room temperature prior to infusion.

**Xyntha Solofuse:**

1. Allow the prefilled dual-chamber syringe of freeze-dried Xyntha to reach room temperature.
2. Remove the contents of the Xyntha Solofuse Kit and place on a clean surface, making sure you have all the supplies you will need.
3. Grasp the plunger rod as shown in the following diagram. Avoid contact with the shaft of the plunger rod. Screw the plunger rod firmly into the opening in the finger rest of the Xyntha Solofuse by pushing and turning firmly until resistance is felt (approximately 2 turns).

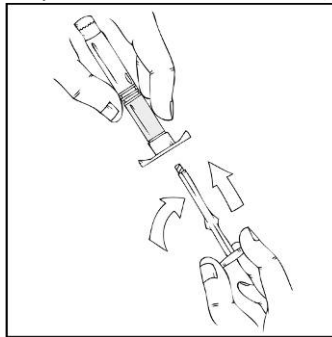

**Note:** Once the white tamper-evident seal is removed it is important to keep the Xyntha Solofuse in the upright position throughout the reconstitution process to prevent possible leakage.

4. Holding the Xyntha Solofuse upright, remove the white tamper-evident seal by bending the seal right to left (or a gentle rocking motion) to break the perforation of the cap and expose the grey rubber tip cap of the Xyntha Solofuse.

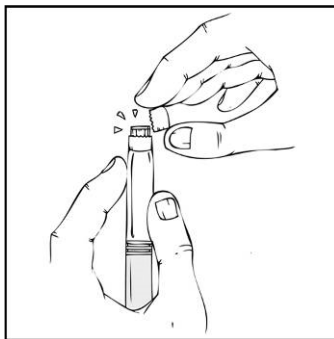

- Remove the protective blue vented sterile cap from its package.

While holding the Xyntha Solofuse upright, remove the grey rubber tip cap and replace it with the protective blue vented cap (prevents pressure build-up). Avoid touching the open end of both the syringe and the protective blue vented cap.

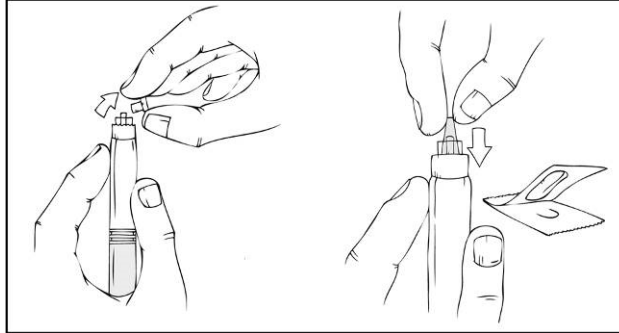

- Gently and slowly** advance the plunger rod by pushing until the two stoppers inside the Xyntha Solofuse meet, and all of the diluent is transferred to the chamber containing the Xyntha powder.

**Note:** To prevent the escape of fluid from the tip of the syringe, the plunger rod should not be pushed with excessive force.

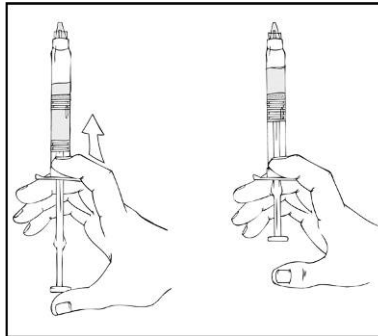

- With the Xyntha Solofuse remaining upright, swirl **gently** several times until the powder is dissolved.

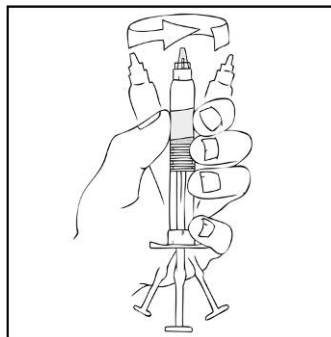

**Note:** The final solution should be inspected visually for particulate matter before administration. The solution should be clear to slightly pearly and colorless. If it is not, the solution should be discarded and a new kit should be used.

- Again, holding the Xyntha Solofuse in an upright position, slowly advance the plunger rod until most, but not all, of the air is removed from the drug product chamber.

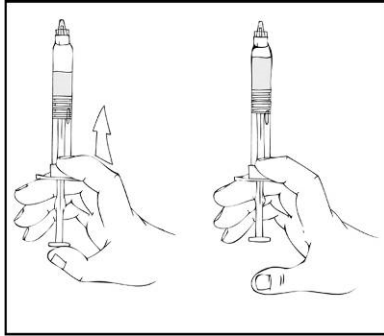

The reconstituted solution may be stored at room temperature prior to administration, but should be administered within 3 hours after reconstitution or removal of the grey rubber tip cap. If the solution is not used immediately, the syringe should be stored upright and the protective blue vent cap should remain on the Xyntha Solofuse until ready to infuse.

### **Infusion (Intravenous Injection)**

Xyntha, when reconstituted, contains polysorbate-80, which is known to increase the rate of di-(2-ethylhexyl) phthalate (DEHP) extraction from polyvinyl chloride (PVC). This should be considered during the preparation and administration of Xyntha, including storage time elapsed in a PVC container following reconstitution. It is important that the recommendations in **4 DOSAGE AND ADMINISTRATION** section be followed closely.

**Note:** The tubing of the infusion set included with Xyntha vial kit and Xyntha Solofuse kit does not contain DEHP.

### **Xyntha Vial kit:**

You should inject Xyntha as instructed by your hemophilia doctor or nurse. Once you learn how to self-infuse, you can follow the instructions in this insert.

Always wash your hands before doing the following procedures. Germ-free methods should be used during injection.

Xyntha should be administered using the pre-filled diluent syringe provided or a single sterile disposable plastic luer-lock syringe. In addition, the solution should be withdrawn from the vial using the vial adapter.

1. Attach the syringe to the luer end of the provided infusion set tubing and perform venipuncture as instructed by your hemophilia doctor or nurse.

2. Apply a tourniquet and prepare the injection site by wiping the skin well with an alcohol swab provided in the kit.



3. Insert the needle on the infusion set tubing into the vein, and remove the tourniquet. Infuse the reconstituted Xyntha product over several minutes. Your comfort level should determine the rate of infusion.

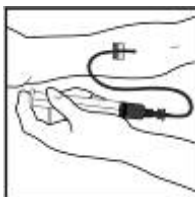

4. After injecting Xyntha, remove the infusion set and discard. The amount of drug product left in the infusion set will not affect your treatment. Dispose of all unused solution, the empty vial(s), and the used needles and syringes in an appropriate sharps container used for throwing away waste that might hurt others if not handled properly.

You should record the lot number of the product every time you use Xyntha. The lot number can be found on the vial label. The peel-off label on the vial may be used to record the lot number.

In the absence of incompatibility studies, reconstituted Xyntha should not be administered in the same tubing or container with other medicinal products. Infusion kit components supplied in this carton are compatible with Xyntha for administration.

The reconstituted Xyntha solution does not contain a preservative and should be used within 3 hours of reconstitution.

#### **Xyntha Solofuse:**

Xyntha is administered by intravenous (IV) infusion after reconstitution of the freeze-dried powder with the diluent (0.9% Sodium Chloride). Both the Xyntha powder and the diluent are supplied within the prefilled dual-chamber syringe. Parenteral drug products should be inspected for particulate matter and discoloration prior to administration, whenever solution and container permit.

Xyntha, as provided in the prefilled dual-chamber syringe, should routinely be administered using the infusion set included in the kit.

1. After removing the protective blue vented cap, firmly attach the intravenous infusion set provided onto the Xyntha Solofuse.

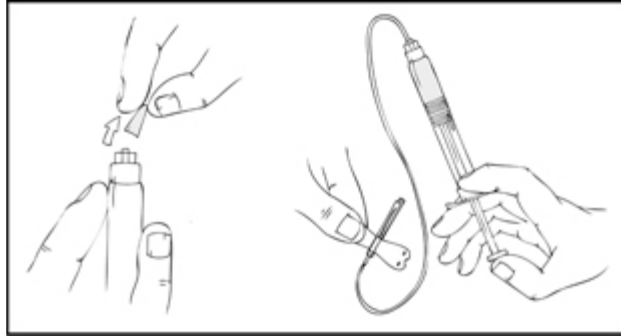

2. Apply a tourniquet and prepare the injection site by wiping the skin well with an alcohol swab provided in the kit.
3. Remove the protective needle cover and perform venipuncture. Insert the needle on the infusion set tubing into the vein, and remove the tourniquet. The reconstituted Xyntha product should be injected intravenously over several minutes. The rate of administration should be determined by the patient's comfort level. As with any intravenous administration, always verify proper needle placement.

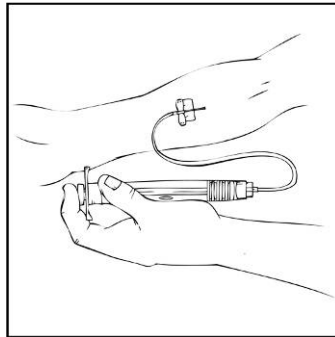

**Reconstituted Xyntha should not be administered in the same tubing or container with other medicinal products.**

4. After infusing Xyntha, remove the infusion set and discard. The amount of drug product left in the infusion set will not affect treatment.

**Note:** Dispose of all unused solution, the empty Xyntha Solofuse, and other used medical supplies in an appropriate container for throwing away medical waste that might hurt others if not handled properly.

#### **Combined Use of a Xyntha Vial Kit and a Xyntha Solofuse Kit**

These instructions are for the combined use of only one Xyntha vial kit and one Xyntha Solofuse Kit.

1. Reconstitute the Xyntha vial using the instructions included with the kit. Detach the empty diluent syringe from the vial adapter by gently turning and pulling the syringe counterclockwise, leaving the contents in the vial and the vial adapter in place.

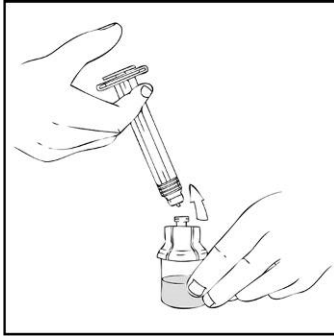

2. Reconstitute the Xyntha Solofuse using the instructions included with the kit, remembering to remove most, but not all, of the air from the drug product chamber.

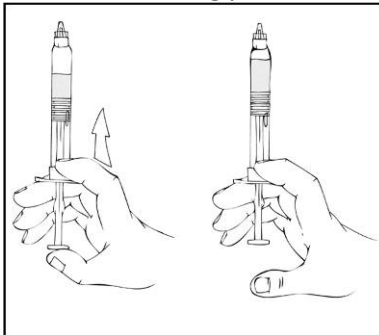

3. After removing the protective blue vented cap, connect the Xyntha Solofuse to the vial adapter by inserting the tip into the adapter opening while firmly pushing and turning the syringe clockwise until secured.

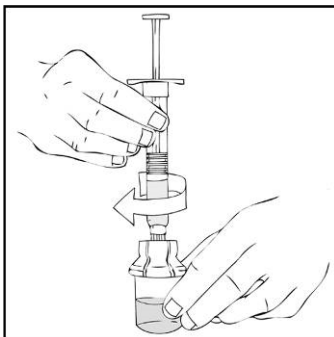

4. Slowly depress the plunger rod of the Xyntha Solofuse until the contents empty into the Xyntha vial. The plunger rod may move back slightly after release.

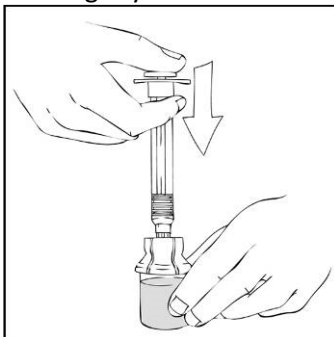

5. Detach and discard the empty Xyntha Solofuse from the vial adapter.  
**Note:** If the syringe turns without detaching from the vial adapter, grasp the white collar and turn.

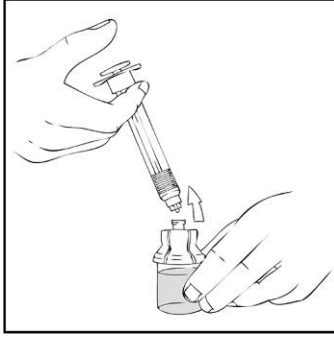

6. Connect a sterile 10 cc or larger luer lock syringe to the vial adapter. You may want to inject some air into the vial to make withdrawing the vial contents easier.

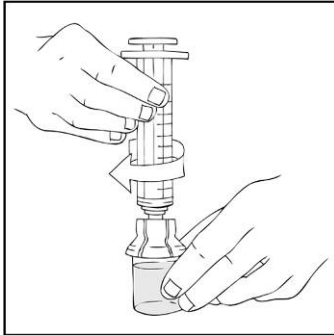

7. Invert the vial and slowly draw the solution into the 10 cc or larger luer lock syringe.

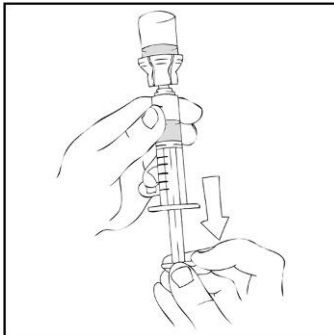

8. Detach the syringe from the vial adapter by gently turning and pulling the syringe counterclockwise. Discard the vial with the adapter attached.
9. Attach the infusion set to the 10 cc or larger luer lock syringe as directed (**see 4 DOSAGE AND ADMINISTRATION**)

**Note:** Dispose of all unused solution, the empty Xyntha Solofuse, and other used medical supplies in an appropriate container for throwing away medical waste that might hurt others if not handled properly.

### **Multiple Xyntha Solofuse Reconstitution to a 10 cc or Larger Luer Lock Syringe**

The instructions below are for the use of multiple Xyntha Solofuse kits with a 10 cc or larger luer lock syringe.



**Note:** Luer-to-luer syringe connectors are not provided in these kits. Instruct patients to contact Pfizer for information on how to obtain the luer-to-luer syringe connectors.

1. Reconstitute all Xyntha Solofuse according to instructions shown above (**see 4 DOSAGE AND ADMINISTRATION**).

Holding the Xyntha Solofuse in an upright position, slowly advance the plunger rod until most, but not all, of the air is removed from the drug product chamber.

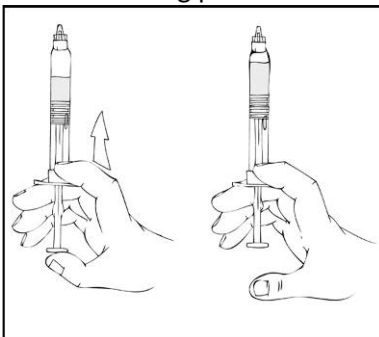

2. Remove the luer-to-luer syringe connector from its package.
3. After removing the protective blue vented cap, connect a sterile 10 cc or larger luer lock syringe to one opening (port) in the syringe connector and the Xyntha Solofuse to the remaining open port on the opposite end.

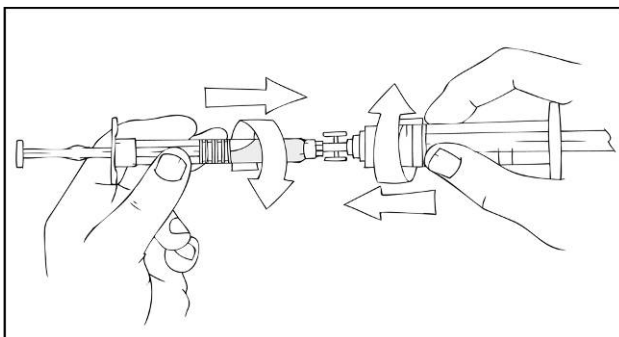

4. With the Xyntha Solofuse on top, slowly depress the plunger rod until the contents empty into the 10 cc or larger luer lock syringe.

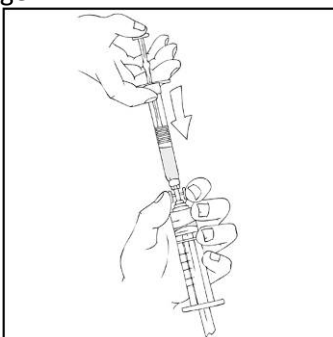

5. Remove the empty Xyntha Solofuse and repeat procedures 3 and 4 above for any additional reconstituted syringes.
6. Remove the luer-to-luer syringe connector from the 10 cc or larger luer lock syringe and attach the infusion set as directed (**see 4 DOSAGE AND ADMINISTRATION**).

**Note:** Dispose of all unused solution, the empty Xyntha Solofuse, and other used medical supplies in an appropriate container for throwing away medical waste that might hurt others if not handled properly.

#### 4.5 Missed Dose

Proceed with your next dose immediately and continue at regular intervals as advised by your health professionals. Do not take a double dose to make up for a forgotten dose.

### 5 OVERDOSAGE

No symptoms of overdose have been reported with recombinant coagulation factor VIII products.

For management of a suspected drug overdose, contact your regional poison control centre.

### 6 DOSAGE FORMS, STRENGTHS, COMPOSITION AND PACKAGING

Table 2 – Dosage Forms, Strengths, Composition and Packaging

Route of Administration	Dosage Form / Strength/Composition	Non-medicinal Ingredients
Intravenous Infusion	Available as 250, 500, 1000, or 2000 IU in single-use vials.	Calcium Chloride Dihydrate (1 mg/vial or prefilled dual-chamber syringe), L-Histidine (6 mg/vial or prefilled dual-chamber syringe), Polysorbate 80 (0.4 mg/vial or prefilled dual-chamber syringe), Sodium Chloride (72 mg/vial or prefilled dual-chamber syringe) [after reconstitution with diluent], Sucrose (12 mg/vial or prefilled dual-chamber syringe).
	Available as 250, 500, 1000, or 2000 or 3000 IU in single-use prefilled dual-chamber syringe.	

#### Xyntha Vial Kit:

Xyntha, Antihemophilic Factor (Recombinant) freeze-dried is supplied in kits that include single-use vials that contain nominally 250, 500, 1000, or 2000 IU per vial. Actual factor VIII activity in IU is stated on the label of each Xyntha Antihemophilic Factor (Recombinant) vial.

In addition, each Xyntha Antihemophilic Factor (Recombinant) kit contains: one pre-filled diluent syringe containing 4 mL 0.9% Sodium Chloride with plunger rod for assembly, one vial adapter, one sterile infusion set, two alcohol swabs, one bandage, one gauze, and one package insert.

#### Xyntha Solofuse:

Xyntha Antihemophilic Factor (Recombinant), is supplied in a kit that includes the Xyntha freeze-dried powder that contain nominally 250, 500, 1000, 2000, or 3000 IU and 4 mL 0.9 % Sodium Chloride solution for reconstitution in a prefilled dual-chamber syringe. Actual factor VIII activity in IU is stated on the label of each Xyntha Antihemophilic Factor (Recombinant) pre-filled dual-chamber syringe.

### 7 WARNINGS AND PRECAUTIONS

Please see **3 SERIOUS WARNINGS AND PRECAUTIONS BOX**.

#### General

It is recommended that, whenever possible, every time that Xyntha is administered to patients the lot number of the product is documented.

### **Carcinogenesis and Mutagenesis**

Xyntha has been shown to be nonmutagenic in the mouse micronucleus assay. No other mutagenicity studies and no investigations on carcinogenesis, impairment of fertility or fetal development have been conducted.

### **Driving and Operating Machinery**

No studies on the ability to drive and use machines have been performed.

### **Immune**

The occurrence of neutralizing antibodies (inhibitors) is well known in patients receiving factor VIII-containing products. Inhibitors most commonly occur early in the treatment course of previously untreated patients, but have also been observed in patients who have previously received large amounts of factor VIII products. All patients using coagulation factor VIII products, including Xyntha, should be monitored periodically for the development of factor VIII inhibitors. In patients with inhibitors (especially high level inhibitors, above 5 Bethesda units (BU)/mL), factor VIII therapy may not be effective, and other therapeutic options should be considered. In addition, if expected factor VIII activity plasma levels are not attained, or if bleeding is not controlled with an appropriate dose, testing should be performed to determine if a factor VIII inhibitor is present. Management of such patients should be directed by health professionals with experience in the care of patients with hemophilia.

### **Hypersensitivity**

As with any intravenous protein product, allergic type hypersensitivity reactions are possible. Patients should be informed of the early signs or symptoms of hypersensitivity reactions including hives (rash with itching), generalized urticaria, tightness of the chest, wheezing, and hypotension.

If allergic or anaphylactic reactions occur, administration of Xyntha should be stopped immediately, and appropriate medical management should be given, which may include treatment for shock. Patients should be advised to discontinue use of the product and contact their hemophilia health professionals and/or seek immediate emergency care, depending on the type and severity of the reaction, if any of these symptoms occur.

## **7.1 Special Populations**

### **7.1.1 Pregnant Women**

Based on the rare occurrence of hemophilia A in women, experience regarding the use of factor VIII during pregnancy is not available. Xyntha should be administered to pregnant women only if the benefit outweighs the risk.

### **7.1.2 Breast-feeding**

No animal reproduction and lactation studies have been conducted with Xyntha. Xyntha should be administered to lactating women only if the benefit outweighs the risk.

### **7.1.3 Pediatrics**

Xyntha is appropriate for use in children of all ages, including newborns.

Clinical data derived from completed studies with moroctocog alfa (AF-CC) in previously treated patients (PTP) (XYNTHA: n=51, 46 patients <6 years of age and 5 patients 6 to <16 years of age) demonstrated a safety profile similar to that of the predecessor product moroctocog alfa (ReFacto). Initial safety and efficacy studies were performed both in previously treated children and adolescents (N=98, ages 7-18 years) and in previously untreated neonates, infants, and children (N=101, ages 0-52 months).

#### 7.1.4 Geriatrics

**Geriatrics (≥ 65 years of age):** Clinical studies of Xyntha did not include sufficient numbers of subjects aged 65 and over to determine whether they respond differently from younger subjects. Other reported clinical experience with factor VIII products has not identified differences in responses between the elderly and younger patients. As with any patient receiving Xyntha, dose selection for an elderly patient should be individualized.

## 8 ADVERSE REACTIONS

### 8.1 Adverse Reaction Overview

The most frequently reported treatment-emergent adverse reaction, on a per infusion basis, was vomiting. Most adverse reactions reported were considered mild or moderate in severity.

In addition, as with any intravenous protein product, allergic type hypersensitivity reactions are possible. Manifestations of hypersensitivity reactions may include hives, generalized urticaria, tightness of the chest, wheezing, hypotension, and anaphylaxis.

Patients with hemophilia A may develop neutralizing antibodies (inhibitors) to factor VIII. As with all coagulation factor VIII products, **patients are to be monitored for the development of inhibitors** that are quantified in Bethesda Units (BUs) using either the Bethesda assay or Bethesda assay with the Nijmegen modification. If such inhibitors occur, the condition may manifest itself as an insufficient clinical response or an unexpectedly low yield of plasma factor VIII activity. In such cases, it is recommended that a specialized hemophilia center be contacted.

Reports of lack of effect, mainly in prophylaxis patients, have been received during the clinical trials and post-marketing setting. The lack of effect and/or low factor VIII recovery has been reported in patients with inhibitors but also in patients who had no evidence of inhibitors. The lack of effect has been described as bleeding into target joints, bleeding into new joints, other bleeding, or a subjective feeling by the patient of a new onset bleeding. In order to ensure an adequate therapeutic response, it is important TO INDIVIDUALLY TITRATE AND MONITOR each patient's dose of Xyntha, particularly when initiating treatment with Xyntha (see **7 WARNINGS AND PRECAUTIONS** and **4 DOSAGE AND ADMINISTRATION**).

If any reaction takes place that is thought to be related to the administration of Xyntha, the rate of infusion should be decreased or the infusion stopped, as dictated by the response of the patient.

### 8.2 Clinical Trial Adverse Reactions

Clinical trials are conducted under very specific conditions. The adverse reaction rates observed in the clinical trials therefore, may not reflect the rates observed in practice and should not be compared to the rates in the clinical trials of another drug. Adverse reaction information from clinical trials may be useful in identifying and approximating rates of adverse drug reactions in real-world use.

System Organ Class (disorder)	Very Common ≥10%	Common ≥1%	Uncommon ≥0.1% and <1%	Rare ≥0.01% and <0.1%	Very Rare <0.01%
Immune system disorders					Anaphylactic reaction
Cardiac disorders					Angina pectoris, tachycardia, palpitations*
Investigations				Lab increase for antibody to Mouse IgG (ReFacto only), Lab increase of FVIII antibody, Lab increase for antibody to CHO protein	CPK increased, Increased aspartate aminotransferase, Increased alanine aminotransferase* Increased bilirubin
Nervous system disorders				Headache, Dizziness	Neuropathy peripheral *, Somnolence, Taste altered
Metabolism & nutrition disorders					Decreased appetite
Musculoskeletal and connective tissue disorders				Arthralgia	Myalgia
Vascular disorders				Hemorrhage, hematoma	Flushing*, Thrombophlebitis* Hypotension, Vasodilation
Respiratory, thoracic & mediastinal disorders				Cough	Dyspnea
Gastrointestinal disorders				Vomiting*, Nausea, Diarrhea, Abdominal pain	
Skin and subcutaneous tissue disorders				Rash	Pruritis, Urticaria, Hyperhidrosis
General disorder & administration site conditions				Pyrexia, Chills, catheter site related reaction	Asthenia, Injection site pain, Injection site reaction, Injection site inflammation*
Factor VIII Inhibition†	FVIII Inhibition in PUPs	FVIII Inhibition in PTPs			

*Adverse reaction frequencies are calculated on an event per infusion basis.*

*(\*) = These adverse reactions were totaled from adverse events and hemophilia events across all studies regardless of relatedness to study drug.*

*All other adverse reactions were totaled across all studies from study drug-related adverse events and hemophilia events ONLY*

*For the adverse reaction frequencies, surgical patients receiving continuous infusion (CI), any day CI is administered is considered one infusion.*

(†) = Frequency for the Adverse Reaction Factor VIII inhibition is expressed on a per patient basis

In a clinical trial (Study 301), 32 out of 101 (32%) previously untreated patients treated with Xyntha manufactured by the previous process developed inhibitors: 16 out of 101 (16%) with a titre >5 Bethesda Units (BU/mL) and 16 out of 101 (16%) with a titre ≤5 BU/mL. The median number of exposure days prior to inhibitor development in these patients was 12 days (range 3 - 49 days). Of the 16 high responder patients, 15 received immune tolerance (IT) treatment. Eleven (11) of the high responders had a titre of <0.6 BU/mL at their latest available test after IT. In addition, IT treatment was started in 10 of the 16 low titre (≤5 BU/mL) patients, 9 of whom had titres <0.6 BU/mL for their latest value. Therefore, IT had an overall efficacy of 80% (20/25), 73% for high responders and 90% for low responders. Five (5) of the 6 remaining low responder patients who did not receive IT also had a titre <0.6 BU/mL for their latest value.

In a clinical trial of Xyntha manufactured by the previous process, one (1) of 113 (0.9%) previously heavily treated patients who were evaluated for efficacy in bleeding episodes developed a high titre inhibitor. Inhibitor development in this patient occurred in the same time frame as the development of monoclonal gammopathy of uncertain significance. The patient was noted initially at a local laboratory to have a treatment-emergent low titre inhibitor at 98 exposure days, which was confirmed at 2 BU/mL at the central laboratory at 113 exposure days. After 18 months on continued treatment with Xyntha, the inhibitor level rose to nearly 13 BU/mL and a bleeding episode failed to respond to Xyntha treatment.

In a pivotal phase 3 study, in which previously treated patients (PTPs) with hemophilia A received Xyntha for routine prophylaxis and on-demand treatment, 94 subjects received at least one dose of Xyntha resulting in a total of 6775 infusions. In this study, the incidence of FVIII inhibitors to Xyntha was the primary safety endpoint. Two patients with low titre, transient inhibitors were observed in these 94 patients (2.1%). In a Bayesian statistical analysis, results from this study (two out of 94 subjects developed an inhibitor, 89 had 50 or more exposure days to XYNTHA) were used to update PTP results from prior supporting studies of Xyntha. This Bayesian analysis indicates that the population (true) inhibitor rate for Xyntha was below a predefined acceptable value of 4.4%; the estimate of the 95% upper limit of the true inhibitor rate was 4.07%.

In a pivotal phase 3 study for surgical prophylaxis in patients with hemophilia A (study 311), one low titre persistent inhibitor and one transient, false-positive inhibitor were reported.

Laboratory increases in anti-FVIII antibody titres, in the absence of inhibitor development, have been observed in clinical trials. In a study of PTPs receiving XYNTHA for routine treatment and prevention of bleeding episodes (study 310) and in a study of PTPs for surgical prophylaxis (study 311), 1 of 94 (1%) patients, and 1 of 30 (3%) patients, respectively, developed anti-FVIII antibodies; these patients did not develop an inhibitor. The clinical significance of these antibodies, in the absence of an inhibitor, is unclear.

In clinical trials of PTPs receiving Xyntha for routine treatment and prevention of bleeding episodes, 0 of 94 (0%) patients in study 310, and 3 of 110 (3%) patients in study 306/307, developed a lab increase in anti-CHO (Chinese hamster ovary, the cell line which is the source of factor VIII for Xyntha) antibody titre, without any apparent clinical effect. In a study of Xyntha for surgical prophylaxis (study 311) 1 of 30 (3%) patients developed a lab increase for antibody to CHO. Twenty of 113 (18%) previously treated patients (PTPs) receiving Xyntha manufactured by the previous process (study 300) had an increase in

anti-CHO (Chinese hamster ovary, the cell line which is the source of factor VIII for Xyntha) antibody titre, without any apparent clinical effect.

Trace amounts of hamster protein may be present in Xyntha. Development of antibodies to hamster protein has been observed in clinical studies, but there were no associated clinical sequelae.

### **8.2.1 Clinical Trial Adverse Reactions – Pediatrics**

In a clinical study (study 313) in pediatric (6 months to <16 years) PTPs ( $\geq 20$  ED) with hemophilia A (FVIII:C  $\leq 2\%$ ), 2 low-titre, clinically silent inhibitor were observed in 49 patients at risk in the study for developing an inhibitor.

### **8.5 Post-Market Adverse Reactions**

There have been spontaneous post-marketing reports of high titre inhibitors developing in previously treated patients.

## **9 DRUG INTERACTIONS**

### **9.4 Drug-Drug Interactions**

No formal drug interaction studies have been conducted with Xyntha. No interactions with other medicinal products are known.

### **9.5 Drug-Food Interactions**

Interactions with food have not been established.

### **9.6 Drug-Herb Interactions**

Interactions with herbal products have not been established.

### **9.7 Drug-Laboratory Test Interactions**

Interactions with laboratory tests have not been established.

## **10 CLINICAL PHARMACOLOGY**

### **10.1 Mechanism of Action**

Xyntha, recombinant coagulation factor VIII, is a glycoprotein with an approximate molecular mass of 170,000 Da, consisting of 1,438 amino acids, which does not contain the non-functional B-domain. Xyntha is a recombinant DNA-based substance which has functional characteristics comparable to those of endogenous factor VIII. Activated factor VIII acts as a cofactor for activated factor IX accelerating the conversion of factor X to activated factor X. Activated factor X converts prothrombin into thrombin. Thrombin then converts fibrinogen into fibrin which forms an insoluble clot.

The factor VIII/von Willebrand factor complex consists of two molecules (factor VIII and von Willebrand factor) with different physiological functions. When infused into a patient with hemophilia, factor VIII binds to von Willebrand factor in the patient's circulation.

Hemophilia A is an X chromosome-linked hereditary disorder of blood coagulation due to decreased levels of factor VIII:C and results in bleeding into joints, muscles or internal organs, either spontaneously or as a result of accidental or surgical trauma. Factor VIII activity is greatly reduced in patients with

hemophilia A. The administration of Xyntha increases plasma levels of factor VIII activity and can temporarily correct the coagulation defect in these patients.

## 10.2 Pharmacodynamics

Factor VIII is the specific clotting factor deficient in patients with hemophilia A (classical hemophilia). The administration of Xyntha, Antihemophilic Factor (Recombinant)[BDDrFVIII] increases plasma levels of factor VIII and can temporarily correct the coagulation defect in these patients.

## 10.3 Pharmacokinetics

### One Stage Assay

In a pivotal cross-over pharmacokinetic study, Xyntha was shown to be bioequivalent to another recombinant factor VIII product (rFVIII, Advate®) in 30 previously treated patients (PTPs) ( $\geq 12$  years) using the one-stage clotting assay. The ratios of geometric least square means of Xyntha-to-Advate® were 100%, 89.8% and 88.0% for K-value,  $AUC_t$  and  $AUC_{\infty}$ , respectively. The corresponding 90% confidence intervals about the ratios of Xyntha to Advate® geometric means were within the bioequivalence window of 80% to 125%, demonstrating bioequivalence of Xyntha to Advate®.

Figure -1: Xyntha vs. Advate

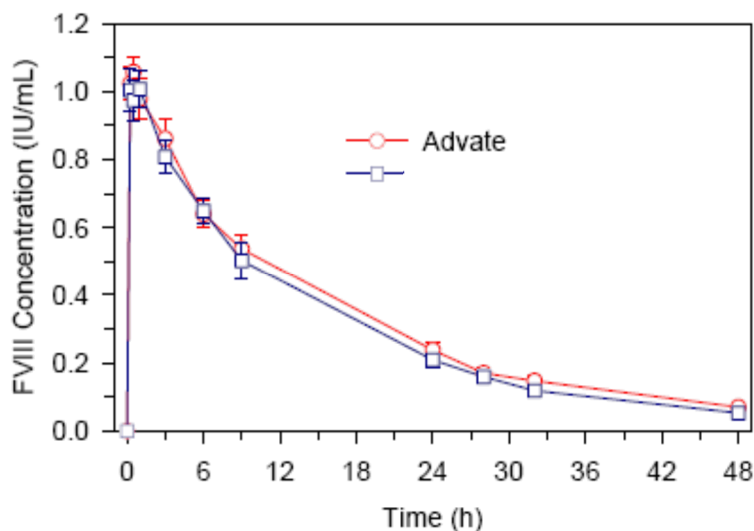

In the same study, the pharmacokinetic parameters for Xyntha were determined at baseline and followed-up in 25 PTPs ( $\geq 12$  years) after repeated administration of Xyntha for six months. At baseline, following a single 2-minute intravenous infusion of 50 IU/kg dose of Xyntha, plasma FVIII:C increased sharply with a mean ( $\pm$ SD)  $C_{max}$  of 1.12 ( $\pm 0.19$ ) IU/mL. Thereafter, the decline of FVIII:C exhibited biphasic disposition characteristics. In the initial phase, the activity dropped at a rate consistent with relatively rapid but limited distribution into extravascular space. The mean ( $\pm$ SD) steady-state volume of distribution was 65.1 ( $\pm 35.1$ ) mL/kg. During the terminal phase, the rate of decline in FVIII:C was slower than the initial phase with a mean ( $\pm$ SD) terminal elimination half-life of 11.8 ( $\pm 5.1$ ) hours. A comparable pharmacokinetic profile was obtained after repeated use for six months. The ratios of



geometric least square means of month 6-to-baseline pharmacokinetic were 107%, 100% and 104% for recovery, AUC<sub>T</sub> and AUC<sub>∞</sub>, respectively. No time-dependent changes in the pharmacokinetic properties of Xyntha were observed (Table 3).

**TABLE 3 MEAN FACTOR VIII PHARMACOKINETIC PARAMETERS FOR 25 PTPS FOLLOWING A RAPID INFUSION OF XYNTHA AT A DOSE OF 50 IU/KG**

Parameter	C <sub>max</sub> (IU/mL)	AUC <sub>T</sub> (hr*IU/mL)	Half- life (hr)	AUC <sub>∞</sub> (hr*IU/mL)	Clearance (mL/hr/kg)	Mean Residence Time (hr)	V <sub>ss</sub> (mL/kg)	Recovery (IU/dL/IU/kg)
<b>Baseline</b>								
Mean	1.12	13.3	11.8	14.2	4.21	16.3	65.1	2.23
SD	0.19	5.2	5.1	5.5	2.08	5.9	35.1	0.39
Min	0.59	4.1	6.4	4.7	2.00	7.9	34.8	1.19
Max	1.41	23.6	33.9	25.0	10.63	40.0	195.1	2.83
<b>Month 6</b>								
Mean	1.24	13.3	11.8	15.0	4.04	19.5	67.4	2.47
SD	0.42	6.7	6.2	7.5	1.87	16.1	32.6	0.84
Min	0.65	5.0	5.8	5.3	1.19	7.6	18.5	1.29
Max	2.60	41.0	32.6	14.8	9.45	89.2	168.8	5.20
Abbreviations: AUC <sub>∞</sub> = area under the plasma concentration-time curve from time zero to infinity; AUC <sub>T</sub> = area under the plasma concentration-time curve from zero to the last measurable concentration; C <sub>max</sub> = peak concentration; SD=standard deviation; V <sub>ss</sub> =volume of distribution at steady-state								

In a pivotal phase III study (Study 311) for surgical prophylaxis, Xyntha pharmacokinetics were evaluated during the perioperative management of patients with hemophilia A who were undergoing major surgery. At the baseline visit, all patients received a single dose of Xyntha of approximately 50 IU/kg. Plasma samples were analyzed for FVIII activity using a validated one-stage (OS) clotting method. Recovery data are available for a total of 30 patients; the mean (± standard deviation [SD]) K-value was 2.11(± 0.43) IU/dL per IU/kg, and the mean (±SD) *in vivo* recovery value was 101.0% (± 20%).

### **Chromogenic Assay**

The labeled potency of Xyntha manufactured by the previous process is based on the European Pharmacopoeia chromogenic substrate assay in which the Pfizer In-House Recombinant Factor VIII Potency Reference Standard has been calibrated to the WHO International Standard using the chromogenic substrate assay.

In a crossover pharmacokinetic study of eighteen (18) previously treated patients using the chromogenic assay, the circulating mean half-life for Xyntha manufactured by the previous process was 14.8 ± 5.6 hours (ranged from 7.6 - 28.5 hours), which was not statistically significantly different from plasma-derived Antihemophilic Factor (Human), (pdAHF), which had a mean half-life of 13.7 ± 3.7 hours (ranged from 8.8 - 25.1 hours). Mean incremental recovery (K-value) of Xyntha manufactured by the previous process in plasma was 2.4 ± 0.4 IU/dL per IU/kg (ranged from 1.9 - 3.3 IU/dL per IU/kg). This was comparable to the mean incremental recovery observed in plasma for pdAHF which was 2.3 ± 0.3 IU/dL per IU/kg (ranged from 1.7 - 2.9 IU/dL per IU/kg).

In additional clinical studies using Xyntha manufactured by the previous process, pharmacokinetic parameters measured using the chromogenic assay were determined for previously treated patients (PTPs) and previously untreated patients (PUPs). In PTPs (n=101; median age 26 ± 12 years), Xyntha manufactured by the previous process had a recovery at Week 0 of 2.4 ± 0.4 IU/dL per IU/kg (range 1.1 to 3.8 IU/dL per IU/kg). In measurements over 4 years of use (Month 3 [n=90], Month 6 [n=87], Month 12 [n=88], Month 24 [n=70], Month 36 [n=64] and Month 48 [n=52]), the mean incremental recovery was reproducible and ranged from 2.3 to 2.5 IU/dL per IU/kg. A subset of 37 study subjects had evaluable pharmacokinetic profiles at both baseline and Month 12. The 90% confidence intervals for the ratios of the mean values of Month 12-to-baseline AUC<sub>T</sub>, AUC<sub>∞</sub>, and K-value were well within the bioequivalence window of 80% to 125%, demonstrating the stability of these pharmacokinetic parameters over 1 year. In PUPs (n=59; median age 10 ± 8.3 months), Xyntha manufactured by the previous process had a mean recovery at Week 0 of 1.5 ± 0.6 IU/dL per IU/kg (range 0.2 to 2.8 IU/dL per IU/kg). The mean incremental recovery for PUPs was stable over time (5 visits during a 2-year period) and ranged from 1.5 to 1.8 IU/dL per IU/kg of Xyntha manufactured by the previous process. Population pharmacokinetic modeling using data from 44 PUPs led to a mean estimated half-life of Xyntha manufactured by the previous process in PUPs of 8.0 ± 2.2 hours.

**Table 4: Mean Factor VIII Pharmacokinetic Parameters for 37 PTPs with Both Baseline and Month 12 Pharmacokinetic Profiles Following A Rapid Infusion of Xyntha manufactured by the previous process at a Dose of 50 IU/KG**

Parameter	C <sub>max</sub> (IU/mL)	AUC <sub>T</sub> (hr*IU/mL)	Half-life (hr)	AUC <sub>∞</sub> (hr*IU/mL)	Clearance (mL/hr/kg)	Mean Residence Time (hr)	V <sub>ss</sub> (mL/kg)	K-value (IU/dL/ IU/kg)
<b>Baseline</b>								
Mean	1.17	13.6	10.6	15.4	3.53	15.0	50.9	2.34
SD	0.24	3.4	2.5	4.5	1.03	3.4	13.0	0.49
Min	0.55	6.0	6.8	7.6	1.78	9.8	36.9	1.10
Max	1.90	21.1	17.2	28.1	6.60	24.7	99.0	3.80
<b>Month 12</b>								
Mean	1.20	14.0	11.4	16.5	3.37	16.1	51.1	2.40
SD	0.29	4.7	3.5	5.7	1.08	4.6	11.4	0.58
Min	0.84	7.8	6.6	8.8	1.49	9.7	21.3	1.67
Max	2.31	32.4	20.1	33.5	5.66	27.8	83.2	4.61

Abbreviations: AUC<sub>∞</sub>=area under the plasma concentration-time curve from time zero to infinity; AUC<sub>T</sub>=area under the plasma concentration-time curve from zero to the last measurable concentration; C<sub>max</sub>=peak concentration; SD=standard deviation; V<sub>ss</sub>=volume of distribution at steady-state.

### Special Populations and Conditions - Pediatrics

Table 5 shows the pharmacokinetic parameters of nine children, four aged 14 or 15 years of age, who are also included in the summary for the adults above, along with five children aged 3.7 to 5.8 years after Xyntha administration. Compared with adults, the half-life of factor VIII after Xyntha is shorter in children and clearance (based on body weight) is approximately 40% higher in children.

**TABLE 5. MEAN ± FVIII PHARMACOKINETIC PARAMETERS IN PREVIOUSLY TREATED PEDIATRIC PATIENTS WITH HEMOPHILIA A AFTER 50 IU/kg XYNTHA**

Parameter	Young Children (n=5)	Adolescents (n=4)
Age [(min–max) yr]	3.7 – 5.8	14 – 15

C <sub>max</sub> (IU/mL)	0.78 ± 0.34	0.97 ± 0.21
AUC <sub>∞</sub> (IU*hr/mL)	12.2 ± 6.50	8.5 ± 4.0
t <sub>½</sub> (hr)	8.3 ± 2.7	6.9 ± 2.4
CL (mL/hr/kg)	6.29 ± 4.87	6.62 ± 2.16
V <sub>ss</sub> (mL/kg)	66.9 ± 55.6	67.1 ± 13.6
Recovery (IU/dL/IU/kg)	1.52 ± 0.69	1.95 ± 0.41

Abbreviations: AUC<sub>∞</sub>=area under the plasma concentration-time curve from time zero to infinity; C<sub>max</sub>=peak concentration; t<sub>½</sub> = terminal half-life; CL = clearance; V<sub>ss</sub>=volume of distribution at steady-state.

## 11 STORAGE, STABILITY AND DISPOSAL

### Xyntha Vial Kit:

Xyntha Antihemophilic Factor (Recombinant) should be stored under refrigeration at a temperature of 2° to 8°C. Xyntha vial may also be stored at room temperature not to exceed 25°C for up to 3 months. The diluent syringe should be stored at 2° to 25°C and should not be used subsequent to expiration of the Xyntha drug product. The patient should write in the space provided on the outer carton the date the product was placed at room temperature. After room temperature storage, the product can be returned to refrigerated storage until the expiration date. Do not store Xyntha vial at room temperature and return it to refrigerated storage more than once. Do not use Xyntha vial after the expiry date on the label.

### Xyntha Solofuse:

Xyntha Antihemophilic Factor (Recombinant) should be stored under refrigeration at a temperature of 2° to 8°C. Xyntha Solofuse may also be stored at room temperature not to exceed 25°C for up to 3 months. The patient should write in the space provided on the outer carton the date the product was placed at room temperature. After room temperature storage, the product can be returned to refrigerated storage until the expiration date. Do not store Xyntha at room temperature and return it to refrigerated storage more than once. Do not use Xyntha Solofuse after the expiry date on the label.

### Xyntha Vial Kit:

Product after reconstitution: The reconstituted solution may be stored at room temperature prior to administration. The product does not contain a preservative and should be used within 3 hours.

### Xyntha Solofuse:

Product after reconstitution: Xyntha should be infused within 3 hours after reconstitution or after removal of the grey rubber tip cap from the Xyntha Solofuse. The reconstituted solution may be stored at room temperature prior to infusion.

## 12 SPECIAL HANDLING INSTRUCTIONS

Freezing should be avoided to prevent damage to the pre-filled diluent syringe. During storage, avoid prolonged exposure of Xyntha vial to light.

## PART II: SCIENTIFIC INFORMATION

### 13 PHARMACEUTICAL INFORMATION

#### Drug Substance

Proper name: Antihemophilic Factor (Recombinant) [BDDrFVIII]

Chemical name: BDDrFVIII (B domain deleted recombinant factor VIII)

Molecular formula and molecular mass: Moroctocog alfa is expressed as a single-chain polypeptide containing 1438 amino acid residues, which is cleaved during processing to the mature, 2-chain form. The total molecular mass including glycosylation is approximately 173 kDa.

Structural formula:

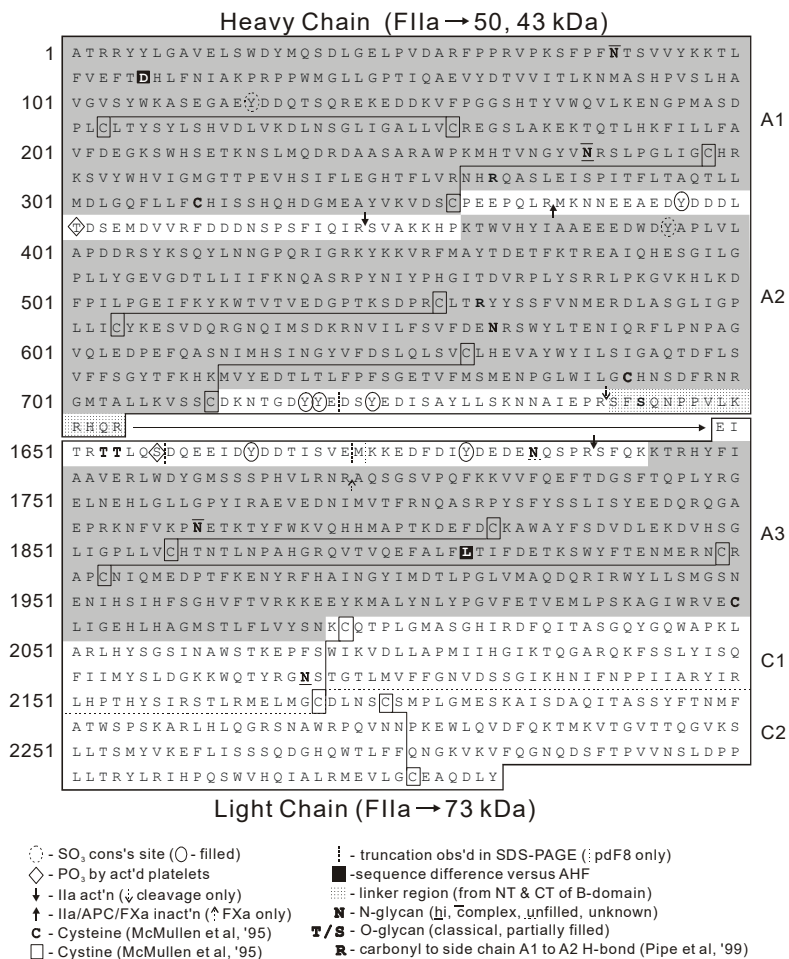

Physicochemical properties: Antihemophilic Factor (Recombinant) the active ingredient in Xyntha, is a recombinant coagulation factor VIII produced by recombinant DNA technology for use in therapy of factor VIII deficiency. Antihemophilic Factor (Recombinant) is a purified glycoprotein with an approximate molecular mass of 170 kDa consisting of 1438 amino acids. It does not contain the B-domain, which has no known function in the circulating form of factor VIII. The amino acid sequence of moroctocog alfa is comparable to the 90 + 80 kDa form of factor VIII. The post-translational modifications and in vitro functional characteristics of moroctocog alfa are comparable to those of endogenous factor VIII.

### Product Characteristics:

Antihemophilic Factor (Recombinant) is secreted by a genetically engineered Chinese hamster ovary (CHO) cell line. The CHO cell line has been extensively studied and found to be free of detectable viruses. The cell line is grown in a chemically-defined cell culture medium that does not contain any materials derived from human or animal sources. The purification process has been refined to affinity purify moroctocog alfa using a column chromatography method that employs a chemically synthesized affinity ligand, replacing the murine monoclonal antibody sepharose resin and eliminating a potential risk of viral contamination associated with the murine monoclonal antibody and its manufacture, and of hypersensitivity reactions to murine protein.

Antihemophilic Factor (Recombinant) is inherently free from the risk of transmission of human blood-borne pathogens, such as human immunodeficiency virus (HIV), hepatitis viruses and parvovirus, because it is not purified from human blood and is manufactured from a well-characterized cell line in the absence of human- or animal-derived materials. To further enhance the viral safety profile and provide additional assurance to the hemophilia A community, a solvent-detergent viral inactivation step and a virus-retaining nanofiltration step have been included during purification.

The protein is purified by a chromatography purification process that yields a high-purity, active product. The potency expressed in international units (IU) is determined using the chromogenic assay of the European Pharmacopoeia. The Pfizer In-House Recombinant Factor VIII Potency Reference Standard has been calibrated against the World Health Organization (WHO) International Standard for factor VIII activity using the one-stage clotting assay. This method of potency assignment is intended to harmonize Xyntha with clinical monitoring using a one-stage clotting assay. The specific activity of Xyntha is 5500 to 9900 IU per milligram of protein.

## 14 CLINICAL TRIALS

### 14.1 Clinical Trials by Indication

The following table lists the registrational studies conducted with ReFacto and ReFacto AF or XYNTHA.

<b>Table 6 - Summary of patient demographics for clinical trials in Hemophilia</b>			
<b>Study #</b>	<b>Study design</b>	<b>Dosage, route of administration and duration</b>	<b>Study subjects (n)</b>
<b>Moroctocog alfa [ReFacto]</b>			
3082A1-300-WW CSR 48478	<b>For PTPs:</b> To assess the safety and efficacy of ReFacto in previously treated patients with severe hemophilia A	Intravenous (IV) administration. Duration of treatment: 12 months with option to continue for 1-year intervals	Enrolled 116 enrolled, 113 of whom received study drug
3082A1-301-WW CSR 49025	<b>For PUPs:</b>	IV administration. Duration of Treatment: Patients were treated	Enrolled 103, 101 patients were treated, 87 patients completed the study. Thirty-

Table 6 - Summary of patient demographics for clinical trials in Hemophilia			
Study #	Study design	Dosage, route of administration and duration	Study subjects (n)
	To assess the safety and efficacy of ReFacto in previously untreated patients with severe hemophilia A	for 50 exposure days (EDs) or up to 5 years, whichever came first.	two (32) patients developed inhibitors during the study.
<b>Morocotocog alfa (AF-CC) [XYNTHA]</b>			
3082B2-310-WW CSR 66997	<b>Routine prophylaxis and on-demand (OD) treatment of PTPs:</b> Double-blind, randomized crossover PK period to assess the bioequivalence (BE) of AF-CC and Advate®, followed by open-label period to evaluate efficacy and safety of AF-CC for use in prophylaxis and OD treatment of bleeding. AF-CC PK at 6 months also evaluated for patients who completed PK period	IV administration. Duration of treatment: Patients were to receive a defined prophylaxis regimen of AF-CC for a minimum of 50 EDs over 6 months.	Enrolled 94 patients, all of whom received at least 1 dose AF-CC. Eighty-nine (89) patients achieved $\geq 50$ EDs; 30 and 25 patients were in the per-protocol populations for BE testing and baseline-to-month 6 analysis, respectively.
3082B2-311-WW CSR 76944	<b>PTPs with severe or moderately severe hemophilia A undergoing elective major surgery:</b> Open-label efficacy and safety study of AF-CC for use in surgical prophylaxis when administered by bolus or continuous infusion	IV administration. Duration of Treatment: Approximately 5 months for most patients.	Enrolled 30 patients, all of whom received at least 1 dose
3082B2-313-WW CSR B1831001	<b>Routine prophylaxis treatment of pediatric PTPs (<math>\geq 20</math> EDs):</b> Open-label study to evaluate prophylaxis treatment, and to characterize the efficacy, safety, and pharmacokinetics of AF-CC in children with severe hemophilia A	IV administration. The study was conducted in two 6 to 12 months segments	Enrolled 50 subjects less than 6 years, with additional one (1) patient when expanded to less than 16 years. 1 subject enrolled in the OD cohort did not receive any study drug. Forty-one (41) (80.4%) subjects completed the study and 10 (19.6%) subjects discontinued early.

Abbreviations: AF-CC=albumin free cell culture; PK=pharmacokinetics; PTPs=previously treated patients; PUPs=previously untreated patients.

## 14.2 Study Results

In a pivotal phase 3 study (study 310), the efficacy of Xyntha was evaluated in routine prophylaxis and on-demand treatment. Prophylaxis was to be initiated at a dose of 30 IU/kg given 3 times per week. The on-demand treatment dosing regimen was to be determined by the investigator. Ninety-four (94) PTPs with moderately severe or severe hemophilia A (FVIII:C  $\leq$ 2%) received at least 1 dose of Xyntha and were included in the intent-to-treat (ITT) population. Eighty-nine (89) patients accrued at least 50 exposure days (EDs) to Xyntha in the study.

Of the 94 patients in the ITT population, 30 patients with FVIII:C  $\leq$ 1% also participated in the double-blind, randomized, crossover PK period of the study and were included in the per-protocol population for analyses of bioequivalence versus another rFVIII product, Advate<sup>®</sup>, and full pharmacokinetic characterization. Both endpoints were surrogate markers for clinical efficacy. The results of these analyses showed that Xyntha is bioequivalent to Advate<sup>®</sup> and the pharmacokinetic profile of Xyntha remained stable after 6 months of repeated use.

Intent-to-treat analysis of clinical efficacy variables in the open-label safety and efficacy period yielded similarly positive outcomes. All 94 patients received Xyntha for routine prophylaxis; the median dose administered was 30.2 IU/kg (range, 6.8 to 76.9 IU/kg). Most patients (57/94; 60.6%) reported no spontaneous bleeding while on routine prophylaxis. The median annualized bleeding rate (ABR) for all bleeding episodes was 1.9 (mean 3.9, range 0 to 42.1), indicating effective prevention of bleeding in the study population. Fifty-three (53) of 94 patients received Xyntha for on-demand treatment; the median dose administered was 30.6 IU/kg (range, 6.4 to 74.4 IU/kg). The majority of bleeding episodes (173/187; 92.5%) resolved with 1 or 2 infusions. This outcome was not restricted to any particular bleeding location as similar efficacy was seen in bleeding occurring in joints, soft tissues/muscles, and other sites. A wide range of doses was used to initiate treatment of bleeding; however, the distribution of doses used to initiate treatment of bleeding was similar regardless of location of bleeding. Patients rated the majority of infusions used to initiate treatment of bleeding as either excellent or good (132/187; 70.6%). The incidence of less than expected therapeutic effect (LETE) occurred at a rate of 0.4% (25/6404 prophylactic infusions) when Xyntha was administered for prophylaxis and 0.5% (1/187 bleeding episodes) when administered for on-demand treatment.

In another series of clinical trials (studies 300 and 301), the efficacy of Xyntha manufactured by the previous process was evaluated in uncontrolled phase 3 studies of 113 PTPs and 101 PUPs who received Xyntha manufactured by the previous process for on-demand treatment, routine prophylaxis, and/or surgical prophylaxis and were followed for up to 6 years. Hemostatic efficacy was rated on an ordinal scale of excellent, good, fair, and none.

In 112 of 113 PTPs treated on-demand, a total of 10,882 bleeding episodes were reported, with a median of 77.5 bleeding episodes per study subject. Of these, the hemostatic efficacy of Xyntha manufactured by the previous process was assessed following the first infusion for treatment of 10,445 bleeding episodes: 9944 (95%) were rated excellent or good in their response to treatment, 429 (4%) were rated fair, and 72 (0.7%) were rated as having no response; 4% (437/10,882) of the bleeding episodes were not rated. Of the 10,882 bleeding episodes, 7981 (73%) were managed with a single infusion, 1612 (15%) required 2 infusions, 623 (6%) required 3 infusions, and 666 (6%) required 4 or more infusions for satisfactory resolution. The mean dose per infusion was 31 IU/kg.

In 100 of 101 PUPs treated on-demand, a total of 2715 bleeding episodes were reported with a median of 19.5 bleeding episodes per study subject. Of these, the hemostatic efficacy of Xyntha manufactured by the previous process was assessed following the first infusion for treatment of 2604 bleeding

episodes: 2459 (94%) were rated excellent or good in their response to treatment, 142 (5%) were rated fair, and 3 (0.1%) were rated as having no response; 4% (111/2,715) of the bleeding episodes were not rated. Of the 2715 bleeding episodes, 1794 (66%) were managed with a single infusion, 502 (19%) required 2 infusions, 229 (8%) required 3 infusions, and 190 (7%) required 4 or more infusions for satisfactory resolution. The mean dose per infusion was 51 IU/kg.

Xyntha manufactured by the previous process has been studied in short-term routine prophylaxis. In uncontrolled phase 3 clinical trials, a mean dose of  $27 \pm 11$  IU/kg per infusion in PTPs (n=85) and a mean dose of  $49 \pm 17$  IU/kg per infusion in PUPs (n=45) was given repeatedly at variable intervals (for PTPs: median 94 weeks, range 3-296 weeks; for PUPs: median 61 weeks, range 2-222 weeks). In PTPs and PUPs, the mean rate of spontaneous musculoskeletal bleeding episodes was lower during periods of routine prophylaxis. PTPs (n=85) had a mean of 10 bleeding episodes (spontaneous and injury-related) per year during the prophylactic periods compared to a mean of 25 bleeding episodes per year during on-demand periods. PUPs (n=45) had a mean of 6 bleeding episodes (spontaneous and injury-related) per year during the prophylactic periods compared to a mean of 11 bleeding episodes per year during the on-demand periods. These non-randomized trial results should be interpreted with caution, as the investigators exercised their own discretion in deciding when and in whom prophylaxis was to be initiated and terminated.

A pivotal phase 3 study (Study 311) for surgical prophylaxis in patients with hemophilia A included PTPs with severe or moderately severe (FVIII:C $\leq$ 2%) hemophilia A undergoing major surgical procedures who received Xyntha. Thirty (30) patients were treated with Xyntha and comprised the ITT population; 29 patients underwent major surgery and completed the study. Thirty (30) subjects were assigned to receive Xyntha by bolus injection (BI; 22 patients) or by continuous infusion (CI; 8 patients) at the health professional's discretion to support surgical hemostasis followed by inpatient and outpatient postoperative care. One subject assigned to CI received Xyntha for a pre-surgery pharmacokinetic assessment only and subsequently elected not to undergo surgery. The 22 patients treated by BI received a total of 942 infusions (ranging from 16 to 72 infusions per patient) for a cumulative total dose of 2,037,386 IU of Xyntha over 682 cumulative total exposure days (EDs) (ranging from 15 to 40 EDs per patient). The 8 patients assigned to treatment by CI, including 1 patient who received only 1 dose for PK assessment, received a total dose of 529,977 IU of Xyntha over 204 total EDs (range 1 to 37 EDs per patient).

Of the 29 patients who underwent surgery, 25 were included in the efficacy evaluable population. Major surgical procedures for the 25 efficacy evaluable subjects were 11 total knee replacements, 1 hip replacement, 5 synovectomies, 1 left ulnar nerve transposition release, 1 ventral hernia repair/scar revision, 1 knee arthroscopy, 1 revision and debridement of the knee after a total knee replacement, 1 hip arthroplasty revision, 1 stapes replacement, 1 ankle arthrodesis, and 1 pseudotumor excision. For the 25 surgical subjects, investigator's ratings of the efficacy at the end of surgery were excellent for 72% (18/25) and good for 28% (7/25) of patients and at the end of the initial postoperative period were excellent for 92% (23/25) and good for 8% (2/25) of patients. Intraoperative blood loss was reported as normal or absent for all procedures. Thirteen of the 25 evaluable patients had blood loss in the postoperative period, and in 10 cases the postoperative blood loss was rated normal. In 3 cases, the postoperative blood loss was rated abnormal: 1 due to hemorrhage following surgical trauma to the epigastric artery, 1 due to an 800 mL blood loss after hip replacement surgery, and 1 after an elbow synovectomy where the blood loss could not be measured by the investigator.



In a supporting study of Xyntha, there were 6 surgical procedures that were classified as major per the definitions of the pivotal surgery study. In all cases, hemostatic efficacy was effectively managed with Xyntha. No patient had blood loss greater than 50 mL, and no blood transfusions were given.

#### *Data in pediatric population <16 years of age*

In study 313, the safety and efficacy of XYNTHA, and FVIII:C pharmacokinetics after XYNTHA infusion in children <16 years of age with moderately severe to severe hemophilia A (FVIII:C  $\leq 2\%$ ) were evaluated in an open-label study. The study (1) compared the efficacy of routine prophylaxis to on-demand treatment in a cohort of pediatric subjects <6 years of age, and (2) compared two routine prophylaxis regimens in a cohort of children <16 years of age (25 IU/kg every other day (EOD) versus 45 IU/kg bi-weekly (BIW)).

Fifty-one (51) subjects with at least 20 prior EDs to FVIII products were enrolled and included in the ITT population. Fifty (50) subjects received at least 1 dose of Xyntha, and 41 subjects completed the study. Nine (9) pediatric subjects <6 years of age (1 of whom did not receive any treatment dose) received on-demand treatment with Xyntha at a median dose of 24 IU/kg for a 6-month period followed by a routine prophylaxis regimen at a dose of 25 IU/kg every other day (EOD) for 12 months. The median ABR observed during the on-demand treatment period was 34.0 (mean 47.0, range 0 to 92.4) compared to 0.6 (mean 1.5, range 0 to 6.2) while on the routine prophylaxis regimen ( $p=0.0040$ ).

Forty-two (42) pediatric subjects <16 years of age received a routine prophylaxis dosing regimen of either 45 IU/kg BIW or 25 IU/kg EOD for 12 months before crossing over to receive the alternate regimen, and 35 subjects provided data for both regimens. Because the 90% confidence interval (CI) for the difference of [(0.03, 2.22)] was inside the prospectively defined equivalence limit of (-3.3), equivalent efficacy was established with respect to ABR for both regimens (mean  $\pm$  SD  $3.3 \pm 5.3$  compared to  $2.2 \pm 4.1$ ).

## **15 MICROBIOLOGY**

No microbiological information is required for this drug product.

## **16 NON-CLINICAL TOXICOLOGY**

### **Single Dose Toxicity**

BDDrFVIII was tested for potential toxicity of a single intravenous (IV) dose in Sprague-Dawley rats and cynomolgus monkeys.

Sprague-Dawley rats (5/sex/group) were administered single doses of 0 (saline), 2500 or 10000 IU/kg of BDDrFVIII intravenously. Animals were observed for 14 days and sacrificed for gross pathology and histopathology. There were no adverse effects related to BDDrFVIII administration; therefore, the no-observed-adverse-effect-level (NoAEL) was  $\geq 10000$  IU/kg.

Two groups of cynomolgus monkeys (1/sex/group) were administered alternate escalating single doses of 200, 400, 800, or 1600 IU/kg BDDrFVIII intravenously every third day in a dose-range finding toxicology study. The animals were subsequently allowed a 14-day washout period and used for a 7-day repeat dose study described below. As expected, there were transient dose-dependent increases in plasma factor VIII activity. During the single dose escalation study there were no adverse effects associated with BDDrFVIII administration; therefore, the NoAEL was  $\geq 1600$  IU/kg.

### **Repeated Dose Toxicity**

BDDrFVIII was tested for potential toxicity of repeated IV doses in Sprague-Dawley rats and cynomologus monkeys.

### **Rat Studies**

Sprague-Dawley rats (4/sex/group) were administered doses of 0 (vehicle), 200, 400, 800, or 1600 IU/kg/day BDDrFVIII intravenously once daily for 10 or 11 days. Satellite groups of 10 males each were included at dose levels of 200 and 800 IU/kg/day to monitor for antibodies against BDDrFVIII at 4 and 19 days after the last dose administration. There were significant BDDrFVIII antibody responses in all animals from the satellite treatment groups as expected when administering a human protein to animals. There were no adverse effects associated with BDDrFVIII administration; therefore, the NoAEL was  $\geq$  1600 IU/kg/day.

The general toxicity of BDDrFVIII was evaluated in a 4-week study in Sprague-Dawley rats. Animals (10/sex/group) were administered 0 (vehicle), 50, 250, or 1250 IU/kg/day BDDrFVIII intravenously once daily for 4 weeks. In addition to standard comprehensive assessments of clinical, clinical laboratory, and anatomic pathology, BDDrFVIII antibody responses were assessed at the end of the treatment period in a subset of the animals. There was a dose-related induction of antibodies reactive to BDDrFVIII in the treated animals. There were slight increases in APTT in a small number of animals from the 250 and 1250 IU/kg/day groups. These minor elevations in APTT were considered secondary to the anti-BDDrFVIII antibody responses which apparently have the potential for neutralization of exogenous human recombinant and endogenous rat factor VIII activity. This neutralization results in prolongation of APTT which is an ex vivo measure of the intrinsic and common pathways of coagulation. There were no adverse effects associated with BDDrFVIII administration; therefore, the NoAEL was  $\geq$  1250 IU/kg/day.

### **Cynomologus Monkey Studies**

A 7-day repeat dose toxicity study in cynomologus monkeys was performed using the same animals as described in the single-dose escalation study with 4 additional naive animals. After a 14-day washout period, 0 (vehicle) (1/sex), 800 (2/sex), or 1250 (2/sex) IU/kg/day BDDrFVIII was administered intravenously once daily for 7 days. In addition to standard clinical laboratory and anatomic pathology assessments, animals were monitored for plasma factor VIII activity. Three of four previously treated animals had decreased plasma factor VIII activity on Day 7 compared to previously untreated animals suggesting the appearance of antibody responses resulting in neutralization of both exogenous recombinant human and endogenous factor VIII activity. Antibodies to BDDrFVIII were not measured in this study. There were no adverse effects associated with BDDrFVIII administration; therefore, the NoAEL was  $\geq$  1250 IU/kg/day.

The general toxicity of BDDrFVIII was evaluated in a 4-week study in cynomologus monkeys (3/sex/group) at doses of 0 (vehicle), 50, 250, or 1250 IU/kg/day BDDrFVIII intravenously. In addition to comprehensive clinical, clinical laboratory, and post-mortem examinations, plasma factor VIII activity was assessed prestudy and on Days 13, 20, and 28, and anti-BDDrFVIII antibodies and neutralizing activity were determined prestudy and on Day 28. One animal was found dead and three sacrificed when moribund. These deaths occurred on or shortly after days of scheduled bleeds (Days 20 and 28/29), and in each case the predominant signs were hemorrhage at sites of venipuncture and/or marked anemia. Clinical signs related to treatment were extensive hemorrhage and bruising at sites of venipuncture. Body weight losses were observed in two moribund animals, and reduced food intake was observed in one moribund animal. Dose and time-related appearance of anti-BDDrFVIII antibodies

were associated with prolongation of APTT, decreases in red blood cell indices (PCV, Hb, and RBC count) and decreased plasma factor VIII activity in animals from the 250 and 1250 IU/kg/day groups.

Treatment-related gross lesions were limited to hemorrhage at sites of venipuncture and at scattered other locations. These changes were observed predominantly in animals from the 250 and 1250 IU/kg/day groups. Histologic changes related to treatment included hemorrhage at sites of venipuncture and in various other organs including the heart, subcutaneous tissues, urinary bladder, spinal canal, skeletal muscle, gastrointestinal tract, and connective tissues. The heart was apparently a predisposition site for histologic lesions of hemorrhage and edema with secondary inflammation and early fibrosis and, sometimes, associated regions of myocardial degeneration.

All adverse effects observed in this study were considered related to the neutralizing antibody response to both administered recombinant human and endogenous monkey factor VIII. Neutralizing antibody responses resulted in an acquired hemophilia syndrome and predisposition to multiorgan hemorrhage and the sequelae of death, moribundity, anemia, and hemorrhage-induced inflammation. The NoAEL for changes related to this syndrome was 50 IU/kg/day, but no adverse effects unrelated to the immunogenicity of BDDrFVIII were observed at any dose level.

After completing the 4-week IV toxicity study with BDDrFVIII in cynomolgus monkeys, it was considered appropriate to conduct a similar study with a plasma-derived human factor VIII product, Octonativ-M<sup>®</sup>, in order to demonstrate the comparability of the changes observed with BDDrFVIII to those with a plasma-derived factor VIII product. Cynomolgus monkeys were administered daily doses of 0 (vehicle) (2/sex), 250 or 1250 (3/sex/group) IU/kg/day of Octonativ-M<sup>®</sup> intravenously for 5 weeks. Parameters examined were similar to those in the BDDrFVIII 4-week study described above.

One animal from the 250 IU/kg/day group was sacrificed moribund on Day 29. Clinical signs related to treatment were hemorrhage at sites of venipuncture. Anti-factor VIII antibodies were detected in all animals treated with Octonativ-M<sup>®</sup>. Clinical laboratory changes included dose- and time-related increases in APTT, decreased red cell indices, increased fibrinogen, and decreased erythrocyte sedimentation rates. The longitudinal kinetics of onset of these changes correlated with dose- and time-related appearance of decreased plasma factor VIII activity and the appearance of plasma factor VIII inhibitors. Treatment-related post-mortem findings in animals from both treatment groups included gross hemorrhage at sites of venipuncture and in the heart. These changes correlated with microscopic lesions of hemorrhage and edema, with associated inflammation and early fibrosis and myocyte degeneration.

Overall, changes observed in this study with a plasma-derived human factor VIII product were analogous to those seen with BDDrFVIII. All adverse effects were considered secondary to the immunogenicity of the test molecule and the acquired hemophilic state of the animals. These effects occurred at IV doses of 250 and 1250 IU/kg/day. There was no NoAEL identified in this study of Octonativ-M<sup>®</sup>.

A 6-week multidose subcutaneous (SC) and IV antigenicity study of BDDrFVIII, which included limited toxicology endpoints, was performed in cynomolgus monkeys. In this study, animals were administered 0 (vehicle) (3/SC route only), 50 (6/route), or 250 IU/kg (4/route) BDDrFVIII either IV or SC every other day for 6 weeks. Limited clinical, hematologic, clinical chemistry, plasma factor VIII activity, factor VIII antibody, and plasma inhibitor determinations were performed. Both SC and IV administration resulted in antibody formation (2/6 animals in the low dose IV treatment group and 100% of the animals in all other groups). Inhibitor antibodies were detected in some animals after

treatment by either route of administration (2/6 animals in the low dose IV-treated group, 4/4 animals in the high dose IV group, 1/6 animals in the low dose SC-treated group, and 2/4 animals in the high dose SC group). Gross necropsy and limited histopathology evaluations were performed. Two deaths were observed in the high dose IV administration group. These were considered secondary to hemorrhage and severe anemia. There were dose- and time-related increases in APTT and decreases in red blood cell indices by both routes. There were clinical and post-mortem observations of hemorrhage at venipuncture sites. Histologic changes of ischemic degeneration in the heart were seen in one animal from the 50 IU/kg IV group and one animal from the 250 IU/kg IV group. These changes were all considered related to the immunogenicity of BDDrFVIII in cynomolgus monkeys, the acquired hemophilic syndrome, and resultant hemorrhagic anemia and myocardial ischemia. There was no NoAEL identified in this study.

### **Reproductive and Developmental Toxicology**

No specific studies to investigate the potential effects of BDDrFVIII on reproductive or developmental function have been conducted. In the 4-week repeat dose toxicity studies, gonadal and secondary sex organs were examined by gross and histopathology, and there were no apparent effects of BDDrFVIII on these tissues.

### **Mutagenic Potential**

BDDrFVIII was assessed for the potential to induce bone marrow micronuclei *in vivo* in the CD-1 mouse. Animals (10/sex/group) were administered 0 (vehicle), 2490, 4980, or 9960 IU/kg/day BDDrFVIII IV for two consecutive days (Tabular Format and Kabi Pharmacia Report 9296824). Five animals/sex/group were sacrificed 24 and 48 hours after the second dose administration. It was concluded that BDDrFVIII did not induce micronuclei in the polychromatic erythrocytes of the bone marrow of mice at any dose level tested.

### **Repeat Dose**

As part of the nonclinical evaluation of Xyntha, a 4-week toxicity study was conducted in cynomolgus monkeys with Xyntha administered by intravenous (IV) injection at dosages of 0, 50, or 1250 IU/kg/day once daily for 29 or 30 days. The toxicity profile from this study was compared with that obtained in a previously conducted 4-week toxicity study in cynomolgus monkeys with original BDDrFVIII administered by IV injection at dosages of 0, 50, 250, and 1250 IU/kg/day.

The administration of Xyntha to monkeys at an IV dosage of 1250 IU/kg/day for 29 or 30 days was generally well tolerated prior to the formation of anti-Xyntha antibodies. The immunologic response against Xyntha consisted of anti-Xyntha antibody production and increased FVIII inhibitors, which resulted in decreased FVIII activity that caused impairment of the coagulation pathway. These findings correlated with clinical pathology changes, hemorrhage, and tissue changes secondary to hemorrhage and were also observed in a previously conducted 4-week toxicity study in cynomolgus monkeys with BDDrFVIII.

The most significant hematologic alteration was a dose-dependent increase in activated partial thromboplastin time (APTT) that was also observed in monkeys at 250 and 1250 IU/kg/day in the previous 4-week toxicity study with original BDDrFVIII. Absolute and relative (to body and brain) mean liver weights were increased (21% to 25%, compared to controls) in male monkeys given 1250 IU/kg/day. Individual liver weights were 74.9, 72.4, 57.6 g (absolute), 99.5, 102.0, 88.2 (% relative to brain weight) and 1.9, 2.1, 1.6 (% relative to body weight) in control males and 80.8, 79.6, 88.5 g (absolute), 123.2, 121.9, 116.8 (% relative to brain weight) and 2.4, 2.3, 2.3 (% relative to body weight) in

males given 1250 IU/kg/day. The weight increase was not considered to be toxicologically significant due to the low magnitude of change and the lack of macroscopic or microscopic correlates.

#### **Local Tolerance Studies**

A separate local tolerance study was not conducted with Xyntha. Instead, local injection sites were evaluated macroscopically and microscopically in the repeat-dose study conducted in monkeys. Macroscopically, red discoloration occurred at the injection sites of all monkeys regardless of treatment (including controls). Microscopically, slight to moderate perivascular and vascular neutrophilic inflammation and/or fibrosis often accompanied hemorrhage at the injection sites in animals given Xyntha, as well as in controls. Hemorrhage was more severe in monkeys given Xyntha (slight to marked at 50 IU/kg/day and mild to severe at 1250 IU/kg/day) when compared with controls (mild to moderate). The macroscopic and microscopic observations with Xyntha were similar to findings in the previous 4-week toxicity study in cynomolgus monkeys conducted with original BDDrFVIII.

#### **Other Toxicity Studies**

Because a novel affinity ligand (TN8.2) is used in the purification process for Xyntha, a non-GLP-compliant, single-dose toxicity study was conducted in rats to assess the acute toxicity of TN8.2 in the event that the peptide leached from the chromatographic resin into the product stream during purification. Because TN8.2 binds to FVIII, in vitro studies were also conducted to evaluate the possible effects of TN8.2 on the clotting activity of rat plasma, human plasma, or Xyntha. TN8.2 has not been detected in any batch of drug substance tested to date.

Single-dose administration of the TN8.2 affinity ligand in rats at 0.6 mg/kg was well tolerated and did not induce acute toxicity.

## PATIENT MEDICATION INFORMATION

### READ THIS FOR SAFE AND EFFECTIVE USE OF YOUR MEDICINE

**XYNTHA<sup>®</sup>, XYNTHA<sup>®</sup> SOLOFUSE<sup>®</sup>**

**Antihemophilic Factor (Recombinant) [BDDrFVIII],**

**Xyntha vial, Xyntha Solofuse prefilled dual-chamber syringe**

Read this carefully before you start taking **XYNTHA** and each time you get a refill. This leaflet is a summary and will not tell you everything about this drug. Talk to your healthcare professional about your medical condition and treatment and ask if there is any new information about **XYNTHA**.

#### **Serious Warnings and Precautions**

- **Xyntha may cause allergic reactions. Signs of allergy include hives (rash with itching), swelling, chest tightness, difficulty breathing, wheezing, faintness, and rapid heart rate. If any of these symptoms occur, stop using Xyntha immediately and contact your hemophilia doctor or seek emergency medical care. The initial infusions of Xyntha should be administered under proper medical supervision, where proper medical care for allergic reactions could be provided.**
- **Notify your hemophilia doctor if you are unable to prevent or control episodes of bleeding with your normal dose of Xyntha. Your body may produce inhibitors against Xyntha. Inhibitors are antibodies produced by your immune system that can prevent Xyntha from working properly. Check with your hemophilia doctor to make sure you are closely monitored with blood tests for the presence of inhibitors.**

#### **What is XYNTHA used for?**

Coagulation Factor VIII is a protein that is necessary for blood to clot. People who have the hereditary bleeding disease factor VIII deficiency (hemophilia A) lack this clotting factor, causing their blood to take longer to form a clot. Xyntha is a form of coagulation factor VIII.

Xyntha is used for the control and treatment of bleeding and the routine and surgical prevention of bleeding in people with hemophilia A.

#### **How does XYNTHA work?**

Administering Xyntha increases blood levels of factor VIII and helps prevent and control bleeding episodes in patients with hemophilia A. Xyntha has the same clot-promoting effects as factor VIII protein made from human plasma.

#### **What are the ingredients in XYNTHA?**

Medicinal ingredients: Xyntha is a coagulation factor VIII product that is produced by recombinant technology.

Xyntha does not contain any human blood or plasma, albumin, preservatives, or added animal or human components in the final product, making it naturally free from the risk of transmission of blood-borne pathogens such as human immunodeficiency virus (HIV), hepatitis viruses, and parvovirus.

Non-medicinal ingredients: Calcium Chloride Dihydrate (1 mg/vial), L-Histidine (6 mg/vial), Polysorbate 80 (0.4 mg/vial), Sodium Chloride (72 mg/vial) [after reconstitution with diluent], Sucrose (12 mg/vial).

**XYNTHA comes in the following dosage forms:**

Xyntha vial kit:

Xyntha is supplied in kits that include single-use vials that contain nominally 250, 500, 1000, or 2000 IU per vial with pre-filled diluent syringe containing 4 mL 0.9% Sodium Chloride for reconstitution.

Xyntha Solofuse kit:

Xyntha Solofuse is supplied in a kit that includes the Xyntha freeze-dried powder that contain nominally 250, 500, 1000, 2000, or 3000 IU and 4 mL 0.9 % Sodium Chloride solution for reconstitution in a prefilled dual-chamber syringe.

**Do not use XYNTHA if:**

- You should not take Xyntha unless your doctor confirms you have hemophilia A. Xyntha should not be used for the treatment of other clotting factor deficiencies such as von Willebrand's disease or hemophilia B.
- Xyntha is produced in hamster cells and may contain trace amounts of hamster proteins. Patients who have a known history of allergic reactions to hamster proteins should not take Xyntha. Your doctor will advise you if you have had allergic reactions to hamster proteins.
- Do not use Xyntha after the expiry date printed on the pack.
- Do not use Xyntha if the packaging is torn or shows signs of tampering.

**To help avoid side effects and ensure proper use, talk to your healthcare professional before you take XYNTHA. Talk about any health conditions or problems you may have, including if you:**

- You are pregnant or planning to become pregnant. It is not known whether Xyntha can affect your ability to have children or harm your developing baby.
- You are breastfeeding or planning to breast feed. It is not known whether Xyntha passes into breast milk.
- You are taking other medicines. Tell your hemophilia doctor if you are taking any other medicines or naturopathic products, including any that you buy without a prescription from your pharmacy, supermarket, or health food shop.

**Other warnings you should know about:**

Your hemophilia doctor will advise you whether or not to take Xyntha or if you need to adjust the dose, or adapt your treatment.

**Tell your healthcare professional about all the medicines you take, including any drugs, vitamins, minerals, natural supplements or alternative medicines.**

**The following may interact with XYNTHA:**

No interactions of Xyntha with other medicinal products are known.

**How to take XYNTHA:**

- You should always follow the specific instructions given by your hemophilia doctor.

- The steps listed below are general guidelines for using Xyntha. If you are unsure of the procedures, please call your hemophilia doctor or nurse before using.

**Usual dose:**

Your hemophilia doctor will decide the dose of Xyntha you will receive. The dose and duration of Xyntha treatment will depend on your individual need for replacement factor VIII therapy.

Your hemophilia doctor may decide to change your dose of Xyntha. In the presence of an inhibitor, you may need higher doses or specific treatment. Contact your hemophilia doctor or nurse immediately if bleeding is not controlled after using Xyntha.

Do not stop taking Xyntha or lower your dose, without checking with your hemophilia doctor, unless you think you are having an allergic reaction.

Your doctor may occasionally need to take blood tests to make sure that the level of factor VIII in your blood is high enough to allow normal blood clotting.

Each Xyntha vial kit contains:

- 1 vial of Xyntha powder
- 1 syringe pre-filled with 4 mL of sodium chloride diluent
- 1 plunger rod for the syringe
- 1 vial adapter
- 1 sterile infusion set
- 2 alcohol swabs
- 1 bandage
- 1 gauze
- 1 package insert

Xyntha is supplied in a sterile, freeze-dried powder form, and it is intended for injection directly into your vein, usually either by yourself, your doctor, your hemophilia nurse, or other trained person.

Before it can be injected, the powder must be dissolved with the liquid diluent supplied (0.9% sodium chloride) to make it an injectable liquid.

**RECONSTITUTION**

Always wash your hands before performing the following procedures. Use germ-free methods during the preparation procedures.



Use only the materials provided in the Xyntha kit for dissolving the Xyntha powder with the sodium chloride diluent.

All components used in the mixing and injection of Xyntha should be used as soon as possible after opening their sterile containers to minimize unnecessary exposure to room air.

Xyntha is administered by intravenous injection after dissolving with the supplied diluent (0.9% sodium chloride) in the pre-filled syringe.

Additional instructions for using Xyntha are provided after **INFUSION (Intravenous Injection)** that detail the use of a Xyntha vial or the combined used of Xyntha vial and a Xyntha Solofuse.

Note: If you use more than one vial of Xyntha per injection, each vial should be dissolved according to the following instructions. The empty syringe should be removed leaving the vial adapter in place, and a separate large luer lock syringe may be used to draw back the dissolved contents of each vial. Do not detach the diluent syringes or the large luer lock syringe until you are ready to attach the large luer lock syringe to the next vial adapter.

1. Allow the vial of freeze-dried Xyntha powder and the pre-filled diluent syringe to reach room temperature.
2. Remove the plastic flip-top cap from the Xyntha vial to expose the central portions of the rubber stopper.

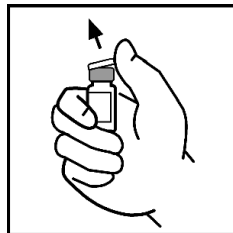

3. Wipe the top of the vial with the alcohol swab provided, or use another antiseptic solution, and allow to dry. After cleaning, do not touch the rubber stopper with your hand or allow it to touch any surface.
4. Peel back the cover from the clear plastic vial adapter package. **Do not remove the adapter from the package.**
5. Place the vial on a flat surface. While holding the adapter in the package, place the vial adapter over the vial. Press down firmly on the package until the adapter snaps into place on top of the vial, with the adapter spike penetrating the vial stopper.

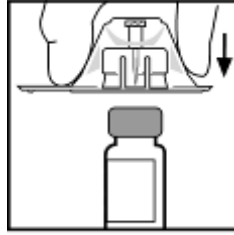

6. Grasp the plunger rod as shown in the diagram. Avoid contact with the shaft of the plunger rod. Attach the threaded end of the plunger rod to the diluent syringe by pushing and turning firmly.

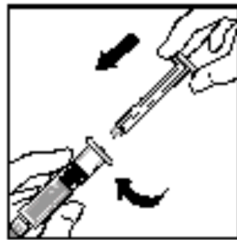

7. Break off the tamper-resistant, plastic-tip cap from the diluent syringe by snapping the perforation of the cap. This is done by bending the cap up and down until the perforation is broken. Do not touch the inside of the cap or the syringe tip. The diluent syringe may need to be recapped (if the dissolved Xyntha is not used immediately), so place the cap on its top on a clean surface in a spot where it would be least likely to become contaminated.

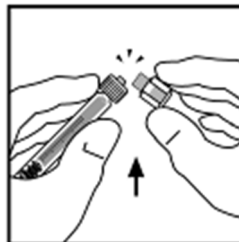

- Lift the package away from the adapter and discard the package.

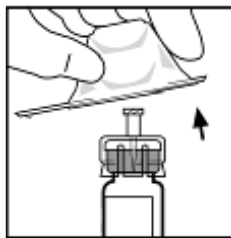

- Place the vial on a flat surface. Connect the diluent syringe to the vial adapter by inserting the tip of the syringe into the adapter opening while firmly pushing and turning the syringe clockwise until the connection is secured.

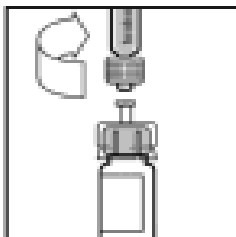

- Slowly depress the plunger rod to inject all the diluent into the Xyntha vial.

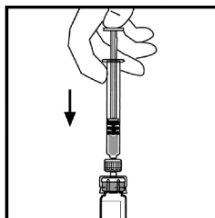

- With the syringe still connected to the adapter, **gently** swirl the contents of the vial until the powder is dissolved.

Note: The final solution should be inspected visually for particulate matter before administration. The solution should be clear to slightly pearly and colorless. If it is not, the solution should be discarded and a new kit should be used.

- Ensuring that the syringe plunger rod is still fully depressed, invert the vial. Slowly draw the solution into the syringe.

Note: If you prepared more than one vial of Xyntha, remove the diluent syringe from the vial adapter, leaving the vial adapter attached to the vial. Quickly attach a separate large luer lock syringe and draw back the dissolved contents as instructed above. Repeat this procedure with each vial in turn. Do not detach the diluent syringes or the large luer lock syringe until you are ready to attach the large luer lock syringe to the next vial adapter.

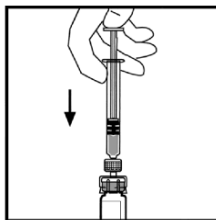

13. Detach the syringe from the vial adapter by gently pulling and turning the syringe counterclockwise. Discard the vial with the adapter attached.

Note: If the solution is not to be used immediately, the syringe cap should be carefully replaced. Do not touch the syringe tip or the inside of the cap.

Xyntha should be infused within 3 hours after dissolving. The dissolved solution may be stored at room temperature prior to infusion.

### **INFUSION (Intravenous Injection)**

You should inject Xyntha as instructed by your hemophilia doctor or nurse. Once you learn how to self-infuse, you can follow the instructions in this insert.

Always wash your hands before doing the following procedures. Germ-free methods should be used during injection.

Xyntha should be administered using the pre-filled diluent syringe provided or a single sterile disposable plastic luer-lock syringe. In addition, the solution should be withdrawn from the vial using the vial adapter.

1. Attach the syringe to the luer end of the provided infusion set tubing and perform venipuncture as instructed by your hemophilia doctor or nurse.
2. Apply a tourniquet and prepare the injection site by wiping the skin well with an alcohol swab provided in the kit.



3. Insert the needle on the infusion set tubing into the vein, and remove the tourniquet. Infuse the reconstituted Xyntha product over several minutes. Your comfort level should determine the rate of infusion.

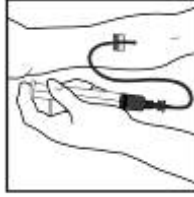

4. After injecting Xyntha, remove the infusion set and discard. The amount of drug product left in the infusion set will not affect your treatment. Dispose of all unused solution, the empty vial(s), and the used needles and syringes in an appropriate sharps container used for throwing away waste that might hurt others if not handled properly.

You should record the lot number of the product every time you use Xyntha. The lot number can be found on the vial label. The peel-off label on the vial may be used to record the lot number.

#### **Combined Use of a Xyntha Vial Kit and a Xyntha Solofuse Kit**

These instructions are for the combined use of only one Xyntha vial kit and one Xyntha Solofuse Kit. For further information, please contact your healthcare provider.

1. Reconstitute the Xyntha vial using the instructions included with the kit. Detach the empty diluent syringe from the vial adapter by gently turning and pulling the syringe counterclockwise, leaving the contents in the vial and the vial adapter in place.



2. Reconstitute the Xyntha Solofuse using the instructions included with the kit, remembering to remove most, but not all, of the air from the drug product chamber.

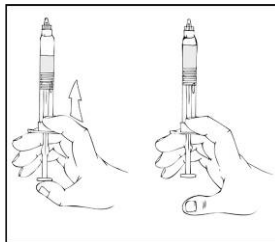

3. After removing the protective blue vented cap, connect the Xyntha Solofuse to the vial adapter by inserting the tip into the adapter opening while firmly pushing and turning the syringe clockwise until secured.

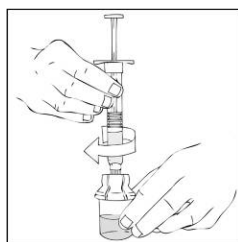

4. Slowly depress the plunger rod of the Xyntha Solofuse until the contents empty into the Xyntha vial. The plunger rod may move back slightly after release.

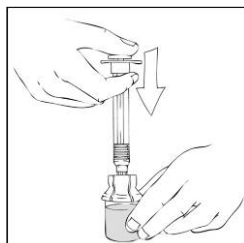

5. Detach and discard the empty Xyntha Solofuse from the vial adapter.

**Note:** If the syringe turns without detaching from the vial adapter, grasp the white collar and turn.

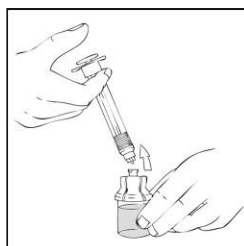

6. Connect a sterile 10 cc or larger luer lock syringe to the vial adapter. You may want to inject some air into the vial to make withdrawing the vial contents easier.

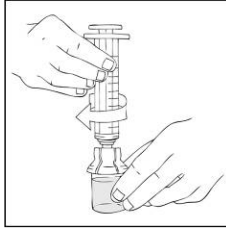

7. Invert the vial and slowly draw the solution into the 10 cc or larger luer lock syringe.

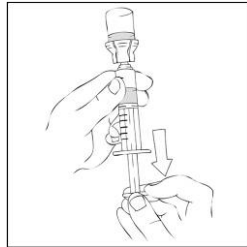

8. Detach the syringe from the vial adapter by gently turning and pulling the syringe counterclockwise. Discard the vial with the adapter attached.
9. Attach the infusion set to the 10 cc or larger luer lock syringe as directed.

**Note:** Dispose of all unused solution, the empty Xyntha Solofuse, and other used medical supplies in an appropriate container for throwing away medical waste that might hurt others if not handled properly.

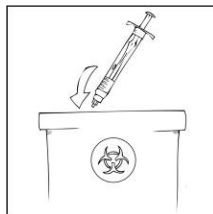

#### **Overdose:**

If you think you, or a person you are caring for, have taken too much XYNTHA, contact a healthcare professional, hospital emergency department, or regional poison control centre immediately, even if there are no symptoms.

#### **Missed Dose:**

If you miss a dose of this medicine, take your next dose immediately and continue at regular intervals as advised by your doctor. Do not take a double dose to make up for a forgotten dose.

#### **What are possible side effects from using XYNTHA?**

These are not all the possible side effects you may have when taking XYNTHA. If you experience any side effects not listed here, tell your healthcare professional.

- allergic reactions

- cold sensation
- chest pain
- rapid heart beat
- sweating
- drowsiness
- muscle weakness
- loss of appetite
- muscle pain
- pain
- coughing
- shortness of breath
- diarrhea
- stomach cramps
- altered taste
- injection site pain or inflammation
- weakness

Contact your hemophilia doctor immediately if your bleeding does not stop as expected.

Your body can also produce inhibitors, or antibodies, against Xyntha, which may prevent Xyntha from working properly. If your bleeding is not controlled with the usual dose of Xyntha, call your hemophilia doctor or nurse. You should be monitored in order to find out whether a factor VIII inhibitor is present.

These are not all the possible side effects of Xyntha. Call your hemophilia doctor or nurse right away if any side effect becomes serious, if you notice any side effects not listed in this leaflet, or if there is any other side effect that concerns you.

Tell all your doctors, dentists, and pharmacists who are treating you that you are taking Xyntha.

If you are about to start taking any new medication, tell your doctor and pharmacist that you are taking Xyntha.

If you become pregnant while taking Xyntha, tell your hemophilia doctor and your doctor who will look after you during your pregnancy.

<b>Serious side effects and what to do about them</b>			
<b>Symptom / effect</b>	<b>Talk to your healthcare professional</b>		<b>Stop taking drug and get immediate medical help</b>
	<b>Only if severe</b>	<b>In all cases</b>	
<b>UNCOMMON</b>			
Headache			✓
<b>RARE</b>			✓



Serious side effects and what to do about them			
Symptom / effect	Talk to your healthcare professional		Stop taking drug and get immediate medical help
	Only if severe	In all cases	
Fever			✓
Nausea			✓
Vomiting			✓
<b>VERY RARE</b>			
Bleeding does not stop as expected after infusing Xyntha		✓	
Using an increasing amount of Xyntha to control your bleed		✓	
Chills			✓
Flushing			✓
Allergic reactions (such as skin rash, itching, chest tightness, wheezing, dizziness, hives, faintness, rapid heartbeat, shortness of breath, and/or a swollen face)			✓

If you have a troublesome symptom or side effect that is not listed here or becomes bad enough to interfere with your daily activities, tell your healthcare professional.

#### Reporting Side Effects

You can report any suspected side effects associated with the use of health products to Health Canada by:

- Visiting the Web page on Adverse Reaction Reporting (<https://www.canada.ca/en/health-canada/services/drugs-health-products/medeffect-canada.html>) for information on how to report online, by mail or by fax; or
- Calling toll-free at 1-866-234-2345.

*NOTE: Contact your health professional if you need information about how to manage your side effects. The Canada Vigilance Program does not provide medical advice.*

#### Storage:

Keep the freeze-dried Xyntha vial and the diluent syringe in the refrigerator at a temperature of 2° to 8°C.

Xyntha may be stored at room temperature not above 25°C for up to 3 months and not to exceed the expiration date. You should write the date in the space provided on the outer carton when you first store Xyntha at room temperature.

After room temperature storage, the product can be returned to refrigerated storage until the expiration date. Do not store Xyntha at room temperature and return it to refrigerated storage more than once.

DO NOT freeze.

DO NOT use after the expiration date (month and year) on the label, even if it has been stored properly.

Avoid exposure of the Xyntha vials to light.

Xyntha does not contain a preservative. Use the dissolved solution as soon as possible after mixing. If the solution is not used right away, it can be stored at room temperature and must be used within 3 hours.

DO NOT use Xyntha if the dissolved solution is not clear to slightly pearly and colorless.

Keep Xyntha (and needles) where young children cannot reach it.

**If you want more information about XYNTHA:**

- Talk to your healthcare professional
- Find the full product monograph that is prepared for healthcare professionals and includes this Patient Medication Information by visiting the Health Canada website: (<https://www.canada.ca/en/health-canada/services/drugs-health-products/drug-products/drug-product-database.html>); the manufacturer's website [www.pfizer.ca](http://www.pfizer.ca), or by calling 1-800-463-6001.

This leaflet was prepared by Pfizer Canada ULC.

Last Revised November 17, 2022

Revision No.: 2.0 Revision Date: 29 May 2023 Reference: Canada Product Monograph Reference Date: 17 November 2022
--